



Peregrine User Manual

v5.0

*Linwei He, Thomas Pritchard, Jack Maggs,
Matthew Gilbert and Hongjia Lu*

limitstate

Page intentionally blank

Contents

1	Introduction	1
1.1	About Peregrine.....	1
1.2	About LimitState.....	1
1.3	Disclaimer	1
1.4	Referencing.....	2
2	Installation & Licensing	2
2.1	Prerequisites.....	2
2.2	Installation.....	2
2.3	Licensing	2
2.3.1	The License Component	3
2.3.2	License Types.....	4
2.3.3	Other License Dialog Options	5
2.4	License Editions.....	6
2.4.1	Free.....	6
2.4.2	Standard.....	6
2.4.3	Professional.....	6
3	Quickstart	6
3.1	Basic Optimization Requirements.....	6
3.2	Example Files Location	7
3.3	Starting from a Grasshopper Defined Geometry	7
3.3.1	Design Domain	7
3.3.2	Loading.....	9
3.3.3	Solving the Optimization Problem	10
3.4	Starting from a Rhino Defined Geometry.....	11
3.5	Combining components for advanced optimization	13
3.6	Units.....	14
4	Basic Concepts.....	14
4.1	Workflow.....	14
5	Component Reference	15
5.1	Structure.....	15
5.1.1	Line Structure (LineStruct).....	15

5.1.2	Surface Structure (SurfStruct).....	17
5.1.3	Define Topology (DefTop)	19
5.2	Loading.....	20
5.2.1	Load Case (LCase).....	20
5.2.2	Line Load (LineL)	22
5.2.3	Surface Load (SurfacEL)	23
5.2.4	Distributed Load (DistL)	24
5.2.5	Point Load (PointL)	25
5.3	Support	26
5.3.1	Supports.....	26
5.3.2	Point Support (PointS)	27
5.3.3	Plane Support (PlaneS).....	28
5.3.4	Plane SupportXYZ (PlaneSXYZ)	29
5.3.5	Directional Support (DirectionalS).....	31
5.4	Domain.....	32
5.4.1	Design Domain (Domain)	32
5.4.2	Design Domain 1D (Domain 1D)	36
5.4.3	Material (Mat)	37
5.5	Solve.....	39
5.5.1	Problem Specification (ProbSpec)	39
5.5.2	Layout Optimization (LO).....	40
5.6	PostProcess.....	43
5.6.1	Geometry Optimization (GO)	43
5.6.2	Simplify (Simplify).....	46
5.6.3	Crossovers (Crossovers).....	48
5.6.4	Filter (Filter)	51
5.6.5	Merge Joints (Merge)	53
5.6.6	Reduce Complexity (Complexity).....	55
5.6.7	Stabilize (Stabilize).....	58
5.7	View.....	60
5.7.1	Gallery Settings (Gallery)	60
5.7.2	View Solution (View)	62

5.7.3	Solution Details (Details).....	63
5.8	Tools	66
5.8.1	Settings (Settings)	66
5.8.2	Remove Duplicated Solutions (DeDupe).....	68
5.9	License	69
5.9.1	Peregrine	69
6	Appendix.....	71
6.1	Theory	71
6.1.1	Layout Optimization.....	71
6.1.2	Geometry Optimization.....	72
6.1.3	Joint Costs.....	73
6.1.4	Example Problem	74
6.2	Known Issues.....	74
7	References	75

List of Figures

Figure 1	- The Peregrine tab on the Grasshopper component panel (ribbon)	2
Figure 2	- Licensing options in the Peregrine License dialog	3
Figure 3	- The Peregrine RLM license details dialog	5
Figure 4	- Error message in the Stabilize component due to license restrictions on functionality	6
Figure 5	- Design Domain - Geometry Defined within Grasshopper	8
Figure 6	- Definition of the Design Domain within Grasshopper	8
Figure 7	- Specification of the Design Domain.....	9
Figure 8	- A Point Load added as a Load Case.....	10
Figure 9	- The Problem Specification and Layout Optimization components	10
Figure 10	- Vizualizing a solution	11
Figure 11	- Optimized solution (displayed in Rhino)	11
Figure 12	- A Design Domain geometry defined in Rhino	12
Figure 13	- Optimized Structure using Rhino defined Domain	12
Figure 14	- Optimization of a complex building (grillages and column sizing)	13
Figure 15	- The unit system can be defined or queried in the ProbSpec component.....	14

Figure 16 – Tooltip showing the units of the Layout Optimization volume output.....	14
Figure 17 – The Line Structure (LineStruct) icon.....	15
Figure 18 – The Line Structure (LineStruct) component	15
Figure 19 – The Surface Structure (SurfStruct) icon.....	17
Figure 20 – The Surface Structure (SurfStruct) component.....	17
Figure 21 – The Define Topology icon	19
Figure 22 - The Define Topology component.....	19
Figure 23 – The Load Case icon.....	20
Figure 24 – The Load Case component.....	21
Figure 25 – The Line Load (LineL) icon	22
Figure 26 – The Line Load (LineL) component.....	22
Figure 27 – The Surface Load (SurfaceL) icon	23
Figure 28 – The Surface Load (SurfaceL) component.....	23
Figure 29 – The Distributed Load (DistL) icon	24
Figure 30 – The Distributed Load (DistL) component.....	24
Figure 31 – The Point Load (PointL) icon	25
Figure 32 – The Point Load (PointL) component.....	25
Figure 33 – The Supports icon.....	26
Figure 34 – The Supports component	26
Figure 35 – The Point Support (PointS) icon	27
Figure 36 – The Point Support (PointS) component.....	27
Figure 37 – The Plane Support (PlaneS) icon	28
Figure 38 – The Plane Support (PlaneS) component	28
Figure 39 – The Plane SupportXYZ (PlaneSXYZ) icon	29
Figure 40 – The Plane SupportXYZ (PlaneSXYZ) component.....	29
Figure 41 – The Directional Support (DirectionS) icon	31
Figure 42 – The Directional Support (DirectionS) component.....	31
Figure 43 – The Design Domain (Domain) icon	32
Figure 44 – The Design Domain (Domain) component – Truss	32
Figure 45 – The Design Domain (Domain) component – Grillage.....	32
Figure 46 – A (simple) optimized truss structure.....	33
Figure 47 – An example of an optimized grillage structure (supported on four columns)	34

Figure 48 – Allowable mesh interfacing configurations.....	34
Figure 49 – The Design domain 1D (Domain 1D) icon.....	36
Figure 50 – The Design domain 1D (Domain 1D) component	36
Figure 51 – The Material (Mat) icon.....	37
Figure 52 – The Material (Mat) component	37
Figure 53 – The Problem Specification (ProbSpec) icon.....	39
Figure 54 – The Problem Specification (ProbSpec) component	39
Figure 55 – The Layout Optimization icon.....	40
Figure 56 – The Layout Optimization component	41
Figure 57 – The Simple2D problem in Rhino. Nodes previewed in green.....	43
Figure 58 – The Geometry Optimization (GO) icon	43
Figure 59 – The Geometry Optimization (GO) component.....	44
Figure 60 – The GO component used to reduce the complexity of a solution.....	45
Figure 61 – The Simplification icon.....	46
Figure 62 – The Simplify component.....	46
Figure 63 – Simplification of a truss structure	48
Figure 64 – The Crossovers icon	48
Figure 65 – The Crossovers component.....	49
Figure 66 – An example of the output of the crossovers functionality.....	50
Figure 67 – The Filter icon.....	51
Figure 68 – The Filter component	51
Figure 69 – Filtering the output from Layout Optimization stage (L = original, R = filtered).....	53
Figure 70 – The Merge Joints icon	53
Figure 71 – The Merge Joints component.....	53
Figure 72 – A node Merge (L = original solution, R = node merge)	55
Figure 73 – The Reduce Complexity icon	55
Figure 74 – The Reduce Complexity component.....	55
Figure 75 – Reducing the complexity of the solution (left = original, right = refined).....	57
Figure 76 – The Stabilize icon	58
Figure 77 – The Stabilize component.....	58
Figure 78 - The Gallery Settings (Gallery) icon	60
Figure 79 – The Gallery Settings (Gallery) component.....	60

Figure 80 – An Example of Gallery output	62
Figure 81 – The View Solution icon.....	62
Figure 82 – The View Solution component.....	62
Figure 83 – The Solution Details icon.....	63
Figure 84 – The Solution Details (Details) component.....	64
Figure 85 – The Settings icon.....	66
Figure 86 – The Settings component	67
Figure 87 – The Remove Duplicated Solutions (DeDupe) icon.....	68
Figure 88 – The Remove Duplicated Solutions (DeDupe) component.....	68
Figure 89 – The License icon	69
Figure 90 – The License component.....	69
Figure 91 – The Peregrine License component and licensing context menu	70
Figure 92 – Example layout optimization	71
Figure 93 – Rationalization of a cantilever truss (a) by using joint cost and GO (b) and GO (c). 74	

1 Introduction

1.1 About Peregrine

Peregrine is a powerful structural layout optimization plugin for Grasshopper, the algorithmic modelling environment built into the Rhino 3D modelling software. Peregrine can be used to identify efficient (minimum volume) layouts of elements forming a truss, for a given design domain and set of loads, supports and material properties. It includes a range of tools that enable the practicality and efficiency of generated designs to be balanced.

Peregrine was originally developed in association with the University of Sheffield, Arup and other partners as part of the UK government-funded BUILD-OPT research project. This collaborative research project involved the Universities of Sheffield, Bath and Edinburgh, AECOM, Arup, BuroHappold, Expedition Engineering, IStructE, Ramboll and the Steel Construction Institute.

Example files can be accessed from:

- The Peregrine Examples desktop shortcut (installation option)
- Start > Peregrine > Example Files
- In the Peregrine folder within Rhino > Plug-ins

For more information, visit limitstate.com/peregrine

1.2 About LimitState

LimitState Ltd was spun out from the University of Sheffield in 2006 to develop and market cutting edge ultimate analysis and design software for engineering professionals. Peregrine takes advantage of LimitState:FORM technology, with the aim of making this useful for building optimization and related problems. This is one of a number of LimitState products, with applications in the structural, geotechnical and mechanical engineering sectors. LimitState aims to be a world leading supplier of computational limit analysis and design software. The company maintains close links with the University of Sheffield, enabling us to draw on and rapidly implement the latest innovations.

For more information, visit limitstate.com/our-company

1.3 Disclaimer

Peregrine undergoes a wide array of tests before release. Notwithstanding this, bugs may exist and therefore no guarantee can be given that the results generated are correct. Use of Peregrine is therefore at the user's own risk. Please refer to the license agreement for further details.

1.4 Referencing

To reference this document, please use:

He L, Pritchard T, Maggs J, Gilbert M and Lu H (2021) *Peregrine User Manual*, LimitState Limited, Sheffield.

2 Installation & Licensing

2.1 Prerequisites

These are the prerequisites for installing Peregrine:

- Rhino 6 SR19 or above

If a copy of Rhino is not already installed, it can be downloaded from the Rhino3D website (rhino3d.com); a fully functional trial version is available. Grasshopper is integrated into Rhino 6 and above.

2.2 Installation

Installation of Peregrine is a straightforward process:

- > [Download the Peregrine installer from www.limitstate.com/peregrine](http://www.limitstate.com/peregrine)
- > [Double-click on the executable to start the installation process](#)
- > [Follow the instructions provided by the installer](#)

2.3 Licensing

Following installation of Peregrine, a new category called Peregrine should be visible as a tab on the component panel (Figure 1) when starting Grasshopper (GH).



Figure 1 - The Peregrine tab on the Grasshopper component panel (ribbon)

If no icons are visible under the Peregrine tab, select “Draw All Components” in the Grasshopper “View” menu.

Detailed instructions for installing and licensing Peregrine are provided in the following section.

2.3.1 The License Component

The Peregrine License component can be found at the right of the Peregrine toolbar (Figure 1). After dragging on to the canvas, right-clicking the component name provides the user with the ability to select between a number of different licensing systems (or Types), as seen in Figure 2:

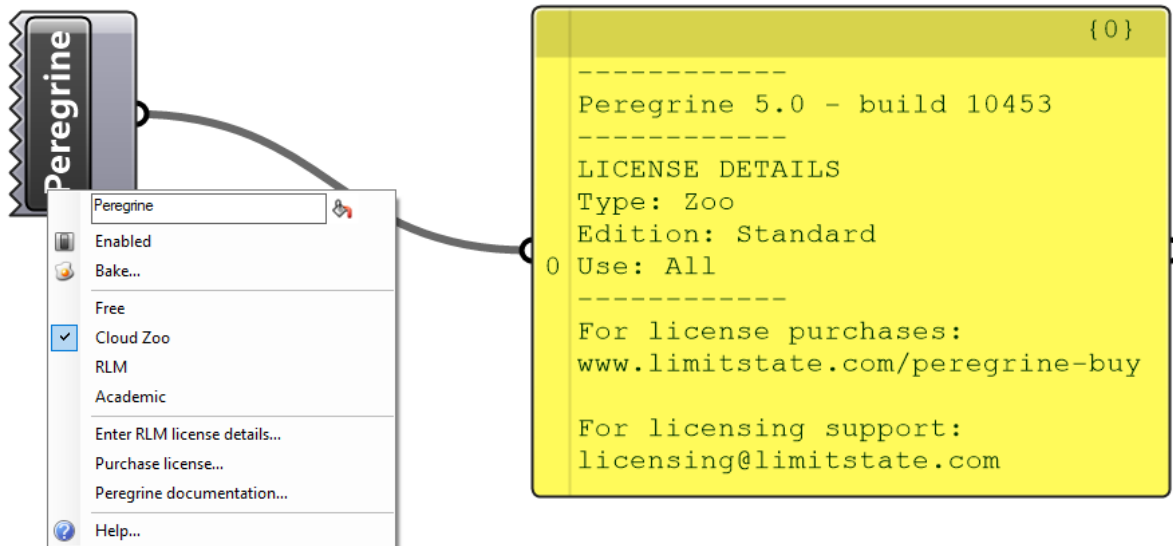

Figure 2 - Licensing options in the Peregrine License dialog

Connecting the output of the License component to a Panel will display information relating to the Peregrine version and currently active license:

- Version and build number
- Type (relating to the method being used to license the plug-in)
- Edition (relating to the functionality that is available)
- Use (relating to the type of usage that the license is valid for e.g. 'non-commercial use only' or 'all')
- Links for further help and information

To change the type of license that is active, open the context menu and select the desired option. Note that this might cause some components in an active document to display error messages relating to e.g. functionality that is not allowed. If this relates to the previous license, right-clicking in free space on the canvas and selecting **Recompute** should update the document. Similarly, you can also remove and re-connect a wire to the component in question.

2.3.2 License Types

2.3.2.1 Free

A **Free** license provides access to the most popular functionality of the plug-in, but restricts the number of nodes that can be specified in the problem to 200 as well as a number of other limitations (see www.limitstate.com/peregrine-buy for more details).

If no other valid license is found, the plug-in will run with a **Free** license by default.

If the user has attempted to specify a different license type, but the plug-in cannot find a valid license of that kind, a **Free** license will be used, so that the basic functionality remains available. However, the **License** component will warn that the requested license type is not active, so that appropriate measures can be taken.

2.3.2.2 Cloud Zoo

Cloud Zoo licensing (or **Zoo** for short) is the most common method of licensing the plug-in. It makes use of the McNeel Rhino Cloud Zoo infrastructure.

Switching to a **Cloud Zoo** license will query your Rhino installation and/or [your Rhinoceros User Account](#) to determine if you have a valid Peregrine license. If you have not yet activated a Peregrine license key on **Cloud Zoo**, you will need to obtain one from LimitState (see shop.limitstate.com/peregrine). Adding the license to your **Cloud Zoo** account is then a matter of logging in and following the “Add License” procedure. For more information on this, please refer to limitstate.com/peregrine-cloud-zoo-licensing.

You can check if you have access to a Cloud Zoo license from within Rhino, by going to:

[File > Properties > Licenses](#)

This will also indicate how long the license will remain active should your machine be taken offline.

2.3.2.3 RLM

[Reprise License Manager \(RLM\)](#) is an alternative to using Cloud Zoo. It requires either:

1. A standalone license (.lic) file on the host machine, or
2. A connection to a networked license server machine with the RLM software installed and a valid network license file.

If a valid **RLM** license is not available, selecting the **RLM** option in the context menu will bring up a dialog (Figure 3) that allows the user to either:

- Enter an **RLM** license activation key, or
- Enter a network location or a local license path

2 - Installation & Licensing

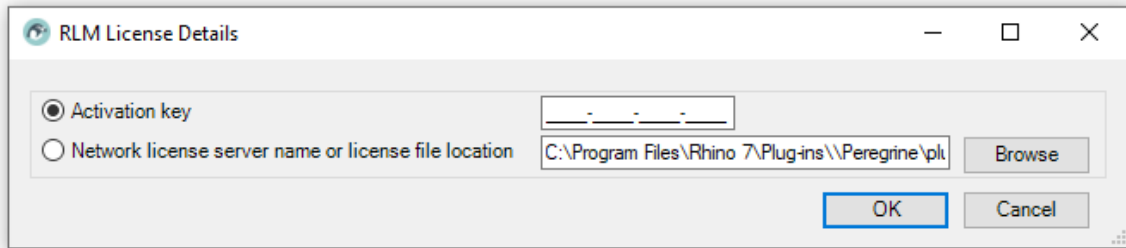

Figure 3 – The Peregrine RLM license details dialog

To obtain a **RLM** license of any kind, [contact LimitState](#). Instructions for installing and maintaining a **RLM** network license server are available in the [Network Licensing Guide](#).

2.3.2.4 Academic

Academic licenses are made available to users on academic networks, wishing to use Peregrine only for research and teaching purposes. The system checks to see if the requesting machine is on a recognized academic network and, if it is, serves a 30 day license, so that the user can work offline.

To check if your institution is currently recognized, on a machine that is connected to the organization’s network, visit www.limitstate.com/academic-licensing and use the “Check Academic License Availability” feature. Note that some institutions use a “split tunneling” VPN system, which will require calls to <http://acad.limitstate.com> to be specifically set to use the IP of the institution.

If your institution is not recognized by our systems, please [get in touch](#) to request that it is added.

2.3.3 Other License Dialog Options

2.3.3.1 Enter RLM license details...

Selecting this option brings up the dialog shown in Figure 3 and allows the user to activate an RLM key (to generate a license) or select a network or local license location.

2.3.3.2 Purchase license...

Selecting this option opens the Peregrine Purchasing page on the LimitState Shop website (shop.limitstate.com/peregrine). You can purchase a Peregrine license from this location.

2.3.3.3 Peregrine documentation...

Selecting this option opens the Peregrine Documentation page on the LimitState website (www.limitstate.com/peregrine-documentation). You can download the Peregrine User Manual from this location.

2.4 License Editions

The availability of certain Peregrine functionality is controlled by the license edition. More information on the features available for each license edition, visit our website:

www.limitstate.com/peregrine-buy

Functionality that is restricted by license edition is referred to herein using red boxes. In the plug-in, error messages on a component will warn the user when a feature is not available, for example as shown in Figure 4:

The editions available are:

2.4.1 Free

As detailed in Section 2.3.2.1, a **Free** license provides access to core functionality, but with some restrictions.

2.4.2 Standard

A **Standard** license Provides access to the most popular functionality of the plug-in and does not restrict the number of nodes and load cases available to use.

2.4.3 Professional

A **Professional** license provides access to all popular as well as the advanced functionality of the plug-in.

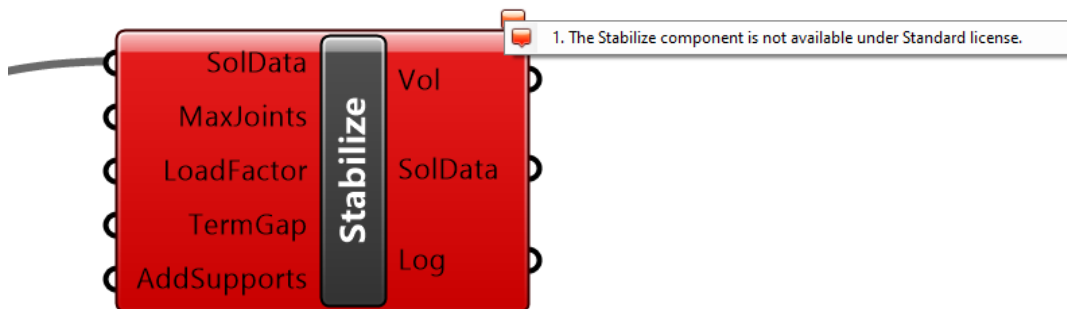

Figure 4 – Error message in the Stabilize component due to license restrictions on functionality

3 Quickstart

3.1 Basic Optimization Requirements

In order to undertake an optimization in Peregrine, a number of model features need to exist:

3 - Quickstart

1. A **design domain**, within which the optimized structure will be situated.
2. **Material properties**, such that the optimum structure can be correctly dimensioned.
3. **Support conditions**, to provide sufficient restraint.
4. One or more **loads** for the optimized structure to resist.

The components within Peregrine allow these features to be quickly defined and used as the basis of an optimization problem. Further functionality then allows the refinement and editing of the output from the optimization, in order to assist the user in realizing a structure that is potentially more practically useful for their needs.

3.2 Example Files Location

Peregrine is installed with a number of example files for you to use and gain an understanding of the software. By default, these are located in the Rhino installation directory, under:

> [<Rhino>\Plug-ins\Peregrine\examples\](#)

Files used in the Quickstart are available within the '[Free](#)' subdirectory. Other example files are arranged into subdirectories according to the license type required to use the functionality being demonstrated.

Example files can be accessed from:

- The Peregrine Examples desktop shortcut (installation option)
- Start > Peregrine > Example Files
- In the Peregrine folder within Rhino > Plug-ins

3.3 Starting from a Grasshopper Defined Geometry

This example builds the design domain for use in the optimization using a geometry defined entirely within the Grasshopper environment.

> [Open the example file *Simple_2D.gh* in Grasshopper.](#)

3.3.1 Design Domain

3.3.1.1 Geometry

In the Rhino environment, a cantilever problem with a rectangular design domain will have been generated (but no optimized solution exists as yet). The cantilever is supported on the left edge and loaded on the right (Figure 5).

3 - Quickstart

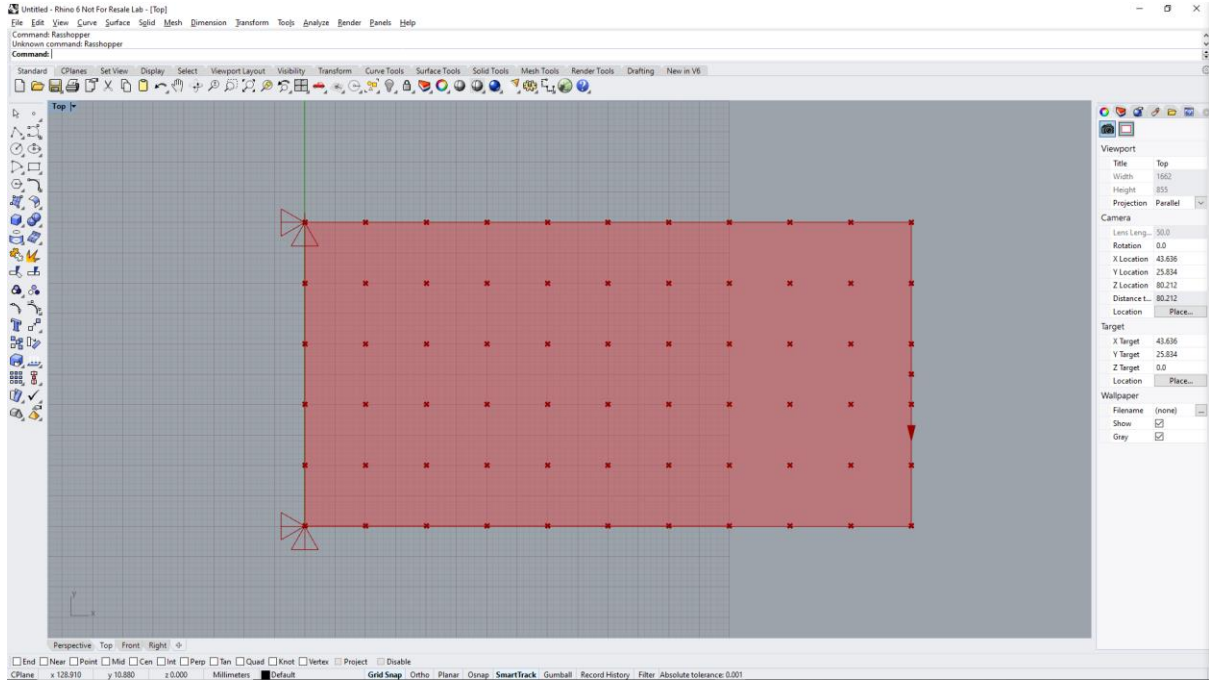

Figure 5 – Design Domain – Geometry Defined within Grasshopper

We shall more closely examine the way in which the domain was generated.

- > Within Grasshopper, zoom into the area containing the Geometry component (top left, Figure 6).

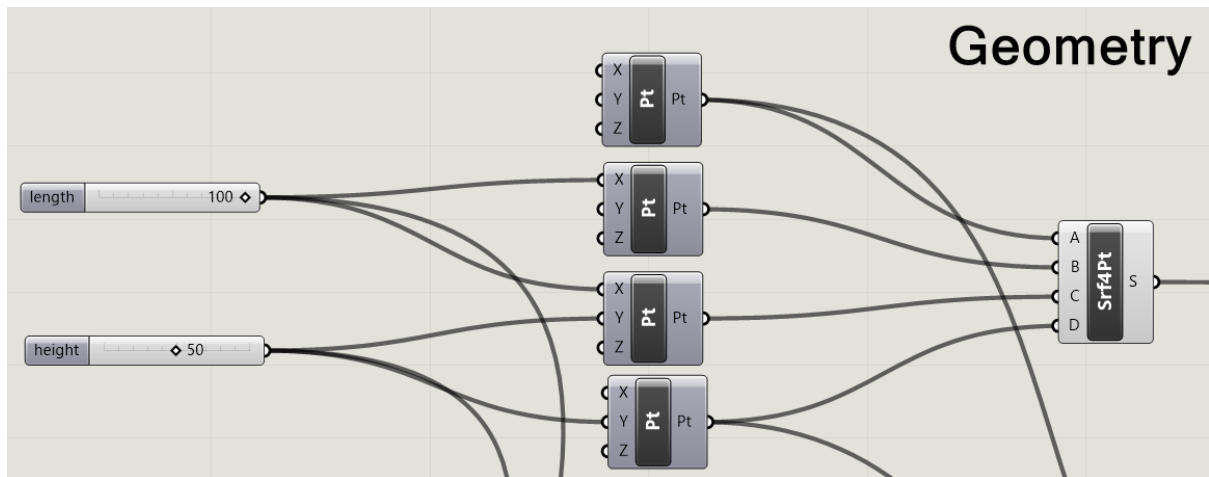

Figure 6 – Definition of the Design Domain within Grasshopper

You will see that four points (**Vector > Construct Point**) have been specified. Each point is defined by an X and Y co-ordinate (Z is omitted in this instance) and these are controlled by **length** and **height** sliders. The co-ordinates are then combined as the input to define a **4 Point Surface** (accessed from the **Freeform** group in the **Surface Component** panel). In this way, the size of the design domain can be altered by adjusting the sliders alone.

3.3.1.2 Material Properties

Tracking the output (**S**) from the **4 Point Surface (Srf4Pt)** it can be seen that the resultant **Surface** is used as The **Mesh** input into the **Domain**. Other inputs include the **Material Properties (Mat)**.

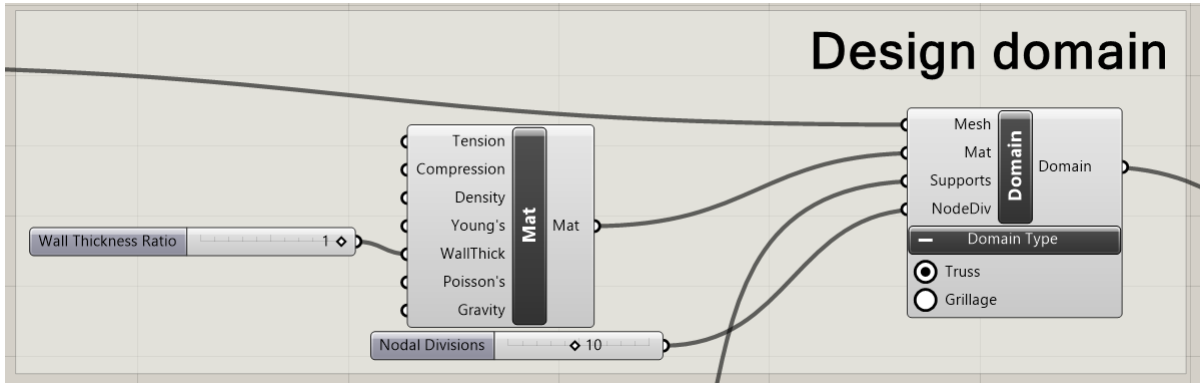

Figure 7 – Specification of the Design Domain

The Material properties and how they affect the results of the optimization are discussed in detail in the Component Reference section (Section 5).

3.3.1.3 Supports

Another input into the **Domain** is the **Supports**. In this particular problem, the supported locations correspond to the two points that define the left boundary of the Design Domain [(0, 0) and (0, 50)]. As such, the input to each **Point Support (PointS)** is the output from one of these original **Point (Pt)** components.

The remaining variable inputs are Boolean operators representing the restraint provided by that support for each of the Cartesian directions. By default, restraint is assumed to be set to **True** and therefore, as there is no additional input to change this state, the two Point Supports are assumed fully fixed. The output from the **Supports** component is then used as input into the **Supports** channel of the **Domain** component.

3.3.1.4 Nodal Divisions

The final input into the **Domain** component is a slider that outlines the number of nodes used in the optimization problem – represented by the number of equally spaced divisions (**Div**) into which the Domain is divided in the diagonal of its bounding box.

3.3.2 Loading

Loading in Peregrine can be applied at a **Point (PointL)**, across a **Surface (SurfaceL)** or along a **Line (LineL)**. Individual loads, or groups of loads, can be made into separate **Load Cases** for input into **LCase**.

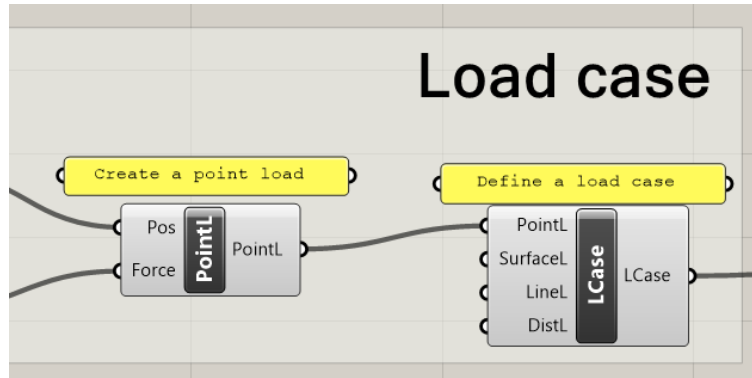

Figure 8 - A Point Load added as a Load Case

The Point Load (*PointL*) accepts a *Position (Pos)* and a *Magnitude (Mag)*. In this problem, a *PointL* of unit magnitude is applied in the downwards (negative) Y direction at mid-height on the right edge of the design domain. The controls for this are situated in the “Point load” group and take further input from the *Geometry* settings.

3.3.3 Solving the Optimization Problem

All the necessary aspects of the problem are now present. We have defined:

- Design domain geometry
- Loading
- Support
- Material properties

The listed features are combined as input into the *Problem Specification (ProbSpec)* component (as the *Domain* and *Load Case*). The output from this component is then used as the *ProbSpec* input into the *Layout Optimization (LO)* component (Figure 9). It is this latter component which controls the optimization. A toggle is added to the *Enable* input, which can then be used as a switch to turn on (and off) the optimizer kernel. Other inputs (e.g. *JointCost*) are optional controls on the problem setup and are explained later in this document.

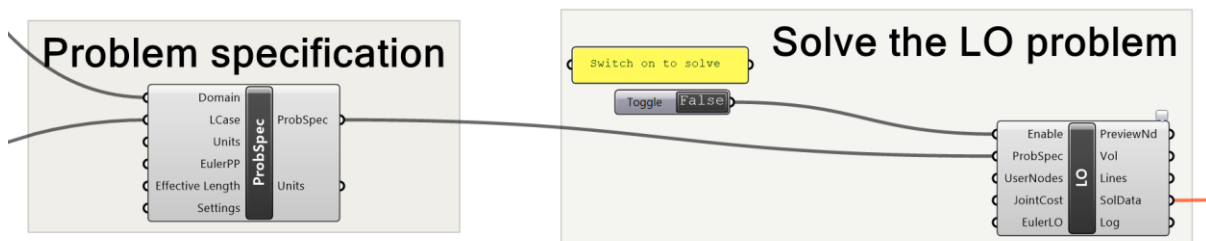

Figure 9 - The Problem Specification and Layout Optimization components

- > To solve the optimization problem, toggle the “Enable” switch.

3 - Quickstart

Once the problem has been solved (which should take less than a second), the optimized truss layout can be displayed in Rhino. This occurs by connecting the **Solution Data (SolData)** output from the **LO** component to the **SolData** input of the **View** component (Figure 10). It should be observed that the connector turns from dark orange to gray, to signify that a valid solution is available and is being displayed. The resultant structural geometry can be highlighted in Rhino by selecting the **View** component in Grasshopper (Figure 11). It is possible to determine the numerical solution (volume of the truss) by hovering over the **Vol** output of either the **Layout Optimization** or **View** components.

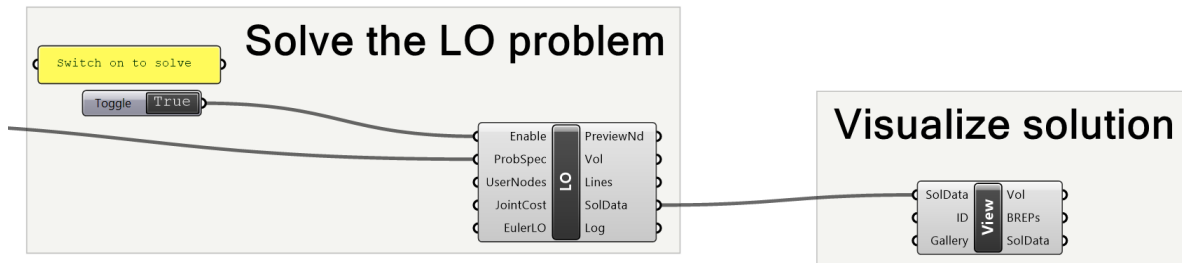

Figure 10 - Visualizing a solution

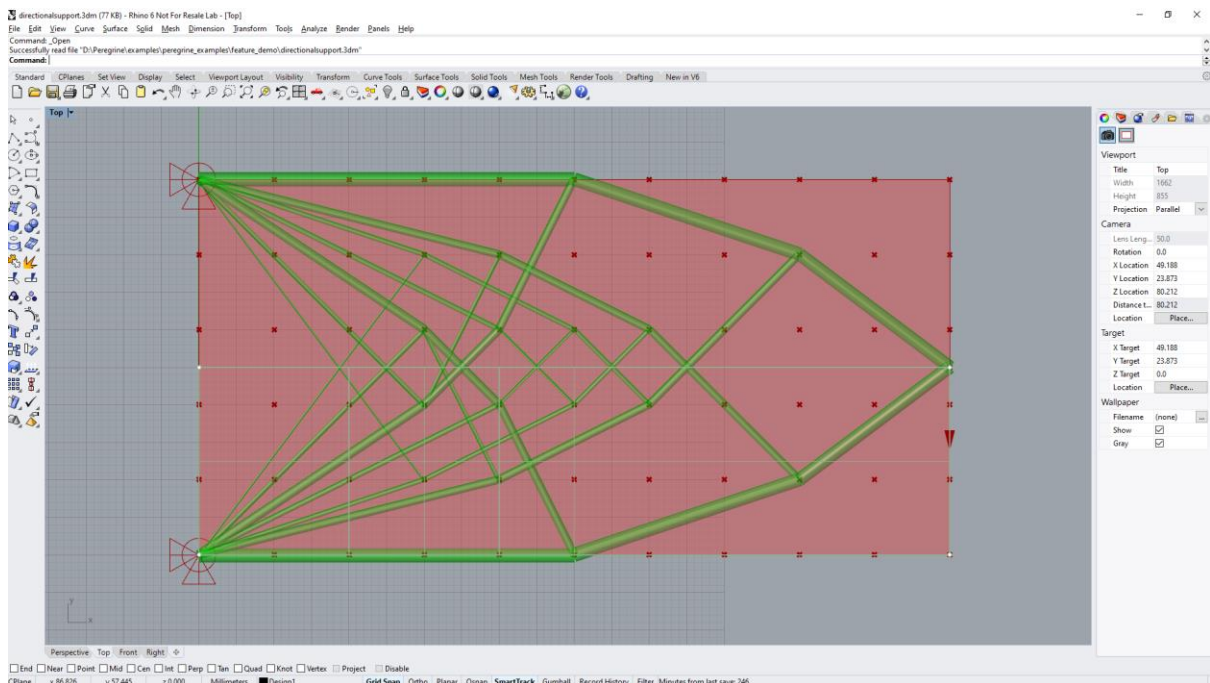

Figure 11 - Optimized solution (displayed in Rhino)

3.4 Starting from a Rhino Defined Geometry

In addition to defining a design domain geometry using Grasshopper inputs, one can also utilize geometries that have been defined within the Rhino environment itself. This is a good method by which complex shapes can be incorporated into the optimization.

- > In Rhino, open the *DirectionalSupport3D.3dm* file

3 - Quickstart

The geometry shown in Figure 12 will be loaded:

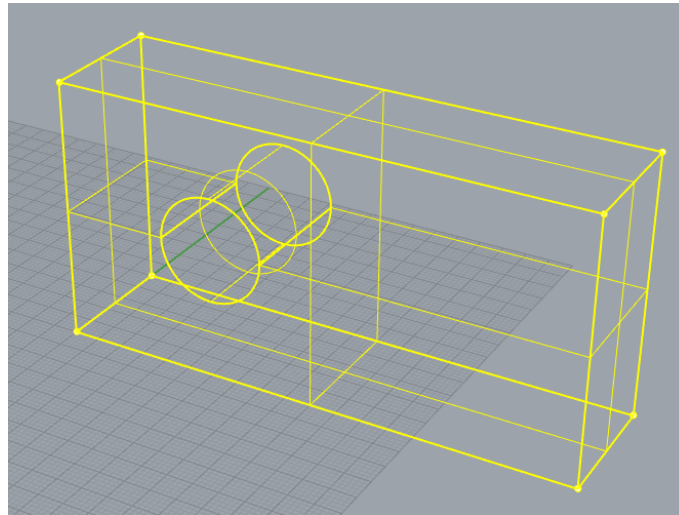

Figure 12 - A Design Domain geometry defined in Rhino

- > In Grasshopper, open the *DirectionalSupport.gh* file

The problem will solve automatically and the resulting optimized structure shown in Rhino (Figure 13):

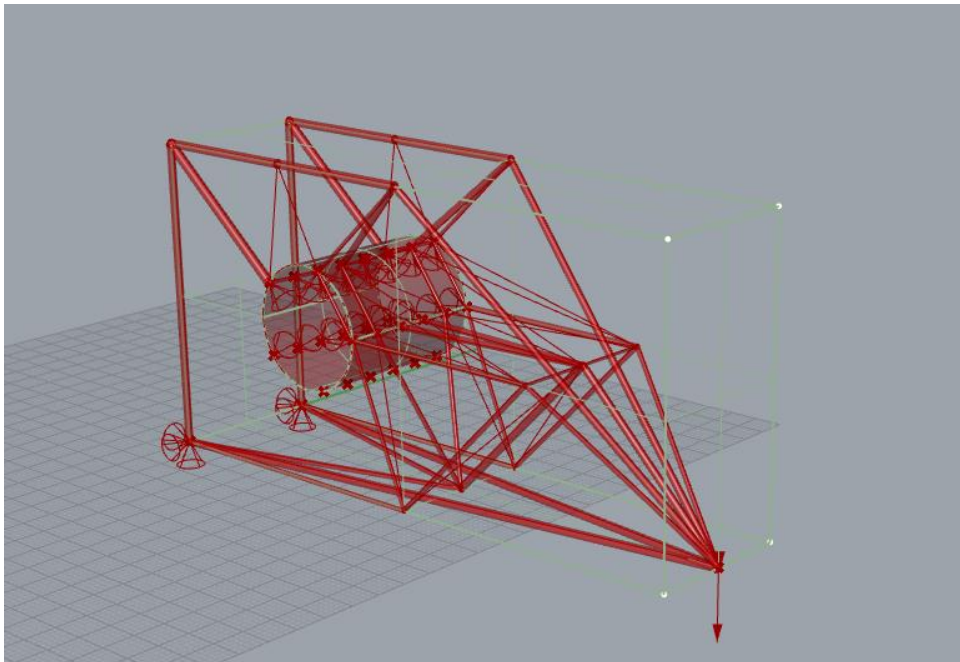

Figure 13 - Optimized Structure using Rhino defined Domain

- > In Grasshopper, explore the components to get an overview of how the problem is constructed

3 - Quickstart

The geometry (**Mesh**) for the **Design Domain** can be seen to originate from a **Brep** component. This, in-turn, references the geometry that is present in Rhino.

- > Right-click the **Brep** component and select “Clear values”

We have just disassociated the geometry from the design domain. Notice that the Peregrine workflow now contains a number of components showing warnings (orange). To associate the Brep geometry once more:

- > Right-click the **Brep** component and select “Set Multiple Breps”
- > In Rhino, right-click and draw a box around the entire geometry (the Breps will turn yellow)
- > Press **Enter**

The geometry will now be associated with the Peregrine problem again. The optimization will run and a solution will be presented.

3.5 Combining components for advanced optimization

Once familiar with the process of optimizing structures using Peregrine, it is possible to develop complex optimization problems and solve them with relative ease. For example, one can optimize grillages for a number of floors of a building and size the columns at the same time. This is explored in [HolisticBuilding.gh](#) (Figure 14):

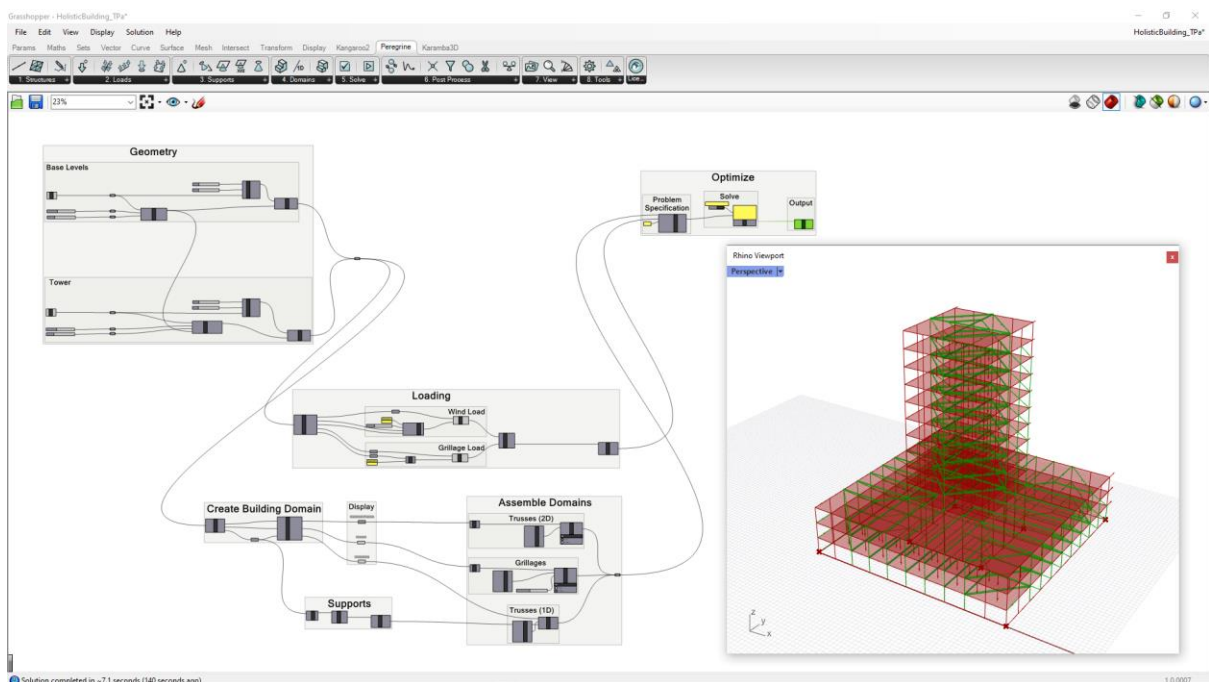

Figure 14 – Optimization of a complex building (grillages and column sizing)

3.6 Units

In Peregrine, all purely geometrical quantities (length, area, volume, position) adopt the same unit system as that used by the current Rhino document. The active setting can be queried in the **Units** output of the Peregrine **ProbSpec** component and, in cases where the system being used is not that which is desired, the units can be changed by entering e.g. “mm” or “m” into the **Units** input (see Figure 15).

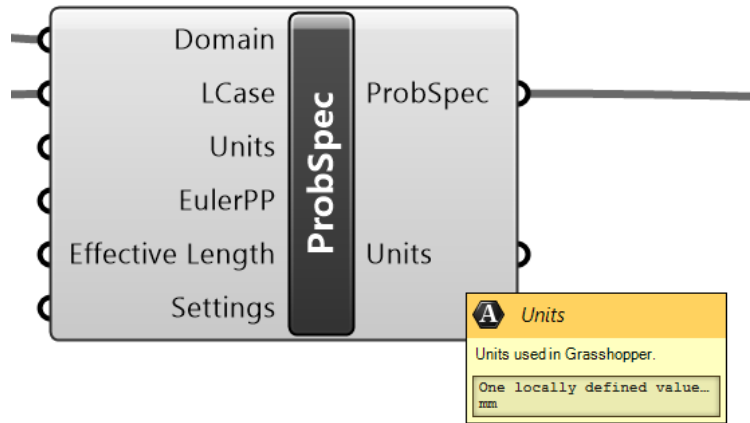

Figure 15 – The unit system can be defined or queried in the ProbSpec component

All other quantities (force, pressure, material properties) use metric units (e.g. kN), and will need to be specified as such. The units of a particular quantity can be seen by hovering over the component input/output that uses that quantity, as shown in Figure 16.

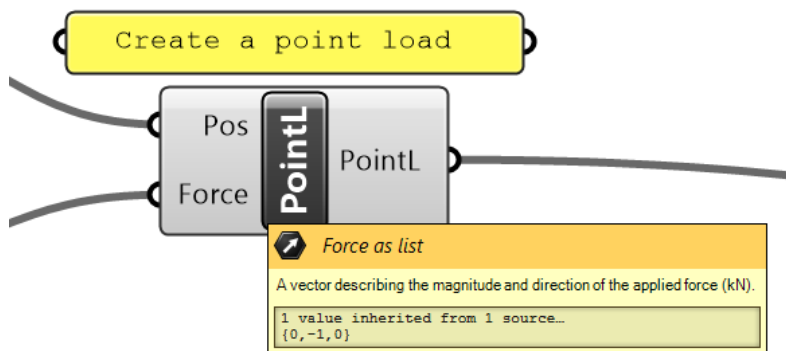

Figure 16 – Tooltip showing the units of the Layout Optimization volume output

4 Basic Concepts

4.1 Workflow

Peregrine is designed to work in a logical left-to-right manner across the Component Panel.

The following are the subsections that appear in the Peregrine category:

- **Structure** – define a starting topology of the user’s own choosing
- **Load** – specify externally applied loads and combine these into load cases
- **Support** – specify a set of support conditions for the problem
- **Domain** – define the geometric and material properties of the volume within which the optimized structure must exist
- **Solve** – combine the design domain and load case(s) into a problem and optimize
- **Post Process** – take the results from the optimization and modify them as needed
- **View** – Visualize the optimized solution(s) in Rhino
- **Tool** – Useful tools for working with Peregrine output
- **About** – About Peregrine

5 Component Reference

5.1 Structure

5.1.1 Line Structure (LineStruct)

5.1.1.1 Icon



Figure 17 - The Line Structure (LineStruct) icon

5.1.1.2 Component

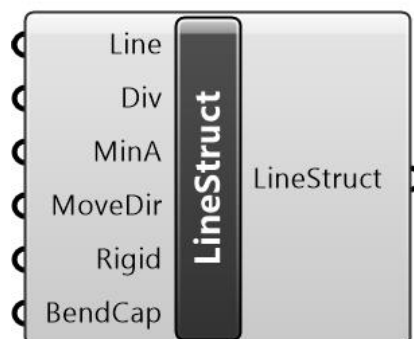

Figure 18 - The Line Structure (LineStruct) component

5.1.1.3 Description

A line or line-based structure. An object for loading or to represent a pre-existing structural component that can be utilized within the optimization process.

5.1.1.4 Summary

The **Line Structure (LineStruct)** component accepts a range of inputs and constructs a line or line structure from these, for use within the optimization (e.g. as an element for loading, or to represent a pre-existing structural component or frame that can be utilized within the optimization process).

The **Line** input accepts a **Line (Ln)** element or elements (double-click the grasshopper canvas and type “line” to bring up a list of line components – select the option titled “Line” with the “create a line between two points” tooltip.)

Divisions (Div) is an integer specifying how many equally sized divisions the line(s) should be divided into for the purpose of e.g. applying load.

Min Area (MinA) is a floating point number describing the minimum cross-sectional area to ascribe to the elements. By default this value is set to 0.

Move Direction (MoveDir) is a vector describing the direction (if any) that the line element can move in. By default this value is set to (0, 0, 0) (no movement).

If **Rigid** is set to *True*, the line element ignores the stress constraints defined in the **Mat** component. By default this value is set to *False*.

Bending Capacity (BendCap) accepts values of 0 or 1, as well as intermediate values. When set to zero (default) it is assumed that the line elements are rigid and cannot bend. When the value is set to 1, the bending capacity of each line is finite, calculated based on the available cross-section, taking due account of the presence of axial load. Note that due to the relative inefficiency of bending as a load transmission mechanism, the finite bending capacity may not be utilized in the optimal structure. By default this value is set to 0.

For an example of a Peregrine problem containing a **LineStruct** component, run the [Structure_LineStruct.gh](#) file.

Note that problems containing multiple domains cannot be used in conjunction with a user-defined line structure. If this attempted, a warning message will be displayed.

5.1.1.5 Input / Output

Input / Output	Description	Default Value
Line (in)	Line or line based structure.	N/A
Div (in)	Specifies how many equally sized divisions the line(s) should be divided into for the purpose of e.g. applying load.	10

5 - Component Reference

MinA (in)	A minimum cross-sectional area to ascribe to the member(s).	0.0
MoveDir (in)	Describes the direction (if any) that the line element can move in.	(0, 0, 0)
Rigid (in)	When True, ignores any limiting stress constraints defined in the Material component.	False
BendCap (in)	Specify a bending capacity from 0.0 (no bending capacity) to 1.0 (full bending capacity).	0.0
LineStruct (out)	A line or line-based structure. An object for loading or to represent a pre-existing structural component that can be utilized within the optimization process.	N/A

5.1.2 Surface Structure (SurfStruct)

5.1.2.1 Icon

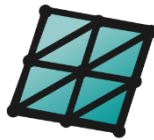

Figure 19 - The Surface Structure (SurfStruct) icon

5.1.2.2 Component

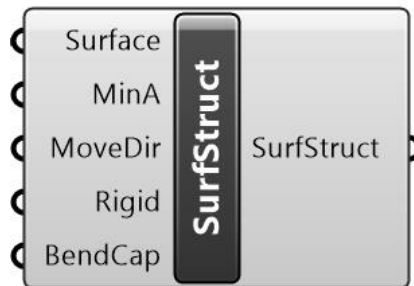

Figure 20 - The Surface Structure (SurfStruct) component

5.1.2.3 Description

A surface structure described by a mesh and having properties used in structural analysis. An object on to which loads are applied or to use as support.

5.1.2.4 Summary

The **Surface Structure (SurfStruct)** component is very similar in operation to the **LineStruct** component. It accepts a range of input and constructs a surface structure from these, for use within the optimization (e.g. as an object for loading).

The **Surface** input accepts a **Meshed Surface or Mesh (M)** object.

Min Area (MinA) is a floating point number describing the minimum cross-sectional area to ascribe to the elements of the mesh. By default this value is set to 0.0

Move Direction (MoveDir) is a vector describing the direction (if any) that the mesh element can move in.

If **Rigid** is set to *True*, the surface ignores the stress constraints defined in the **Mat** component.

Bending Capacity (BendCap) accepts values of 0 or 1, as well as intermediate values. When set to zero (default) it is assumed that the surface elements are rigid and cannot bend. When the value is set to 1, the bending capacity of each element on the surface is finite, calculated based on the available cross-section, taking due account of the presence of axial load. Note that due to the relative inefficiency of bending as a load transmission mechanism, the finite bending capacity may not be utilized in the optimal structure.

For an example of a Peregrine problem containing a **SurfStruct**, run the [Structure_SurfStruct.gh](#) file.

5.1.2.5 Input / Output

Input / Output	Description	Default Value
Mesh (in)	Meshable surface(s) for load application. Note that loading is distributed at the corner points of any input geometry (i.e. use meshes for best coverage).	N/A
MinA (in)	A minimum cross-sectional area to ascribe to the member(s)	0.0
MoveDir (in)	Describes the direction (if any) that the surface can move in.	(0, 0, 0)
Rigid (in)	When True, ignores any limiting stress constraints defined in the Material component.	False
BendCap (in)	Specify a bending capacity from 0.0 (no bending capacity) to 1.0 (full bending capacity).	0.0
SurfStruct (out)	A surface structure described by a mesh and having properties used in structural analysis. An object on to which loads are applied or to use as support.	N/A

5.1.3 Define Topology (DefTop)

5.1.3.1 Icon



Figure 21 - The Define Topology icon

5.1.3.2 Component

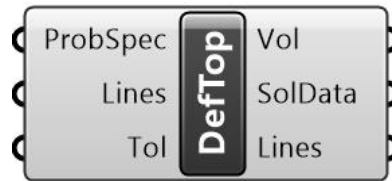

Figure 22 - The Define Topology component

5.1.3.3 Description

Output topology as line elements. Checked and fixed to ensure nodal equilibrium and domain compliance.

5.1.3.4 Summary

The **Define Topology** component allows the user to define a 2D structure within Rhino and to determine its efficiency, as well as to perform post-optimization steps to ascertain whether the layout can be improved upon.

The component accepts a **Problem Specification (ProbSpec)** and a topology as a series of **Lines** (or Polylines). The **Lines** can e.g. be imported via the use of a **Curve (Crv)** component into which the topology is passed through the use of the “*Set multiple curves*” command.

Note that, as part of the functionality, the input topology is validated. If the topology is found to be unstable, or if it contains parts that lie outside the design domain, a preliminary Geometry Optimization is undertaken and will be pushed to grid or vertex of domain if it's close enough. This distance is defined by the **Tolerance (Tol)** which is the fraction of the longest diagonal of the domain below which member end points may be moved. By default this value is set to 0.01.

The output consists of:

A **Volume (Vol)**, which is the volume of the solution structure.

The **Solution Data (SolData)** output packages together all the required data relating to the optimization problem and optimal (least volume) structure in a form that can be used as input into the **Post-Process** stages or displayed within the Rhino environment.

Lines, which is a list of all the elements in the structure.

For an example of a Peregrine problem containing a **Define Topology** component, run the [Structure_ConstructTopology.gh](#) file.

5.1.3.5 Input / Output

Input / Output	Description	Default Value
ProbSpec (in)	A combination of one or more Domain(s) and Load Case(s) for input into the Layout Optimization (LO).	N/A
Lines (in)	A user-defined structural topology formed from lines or polylines.	N/A
Tol (in)	Measure of the proximity of member end points to the edge of the design domain. Above this value, the joint will be pushed back inside. The longest diagonal of the model bounding box is determined and the proximity is the percentage of this measure which is used as the "search area" for domain violation.	0.01
Vol (out)	Volume of the solution structure (in document units).	N/A
SolData (out)	Optimization solution data.	N/A
Lines (out)	Output topology as line elements. Checked and fixed to ensure nodal equilibrium and domain compliance.	N/A

5.2 Loading

5.2.1 Load Case (LCCase)

5.2.1.1 Icon



Figure 23 – The Load Case icon

5.2.1.2 Component

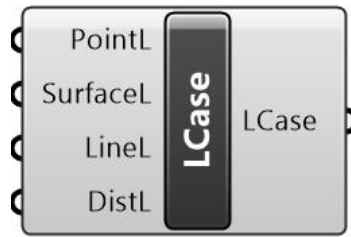

Figure 24 - The Load Case component

5.2.1.3 Description

A load or group of loads to be applied to the structure as an independent case.

Note:

- Specification of **multiple load cases** requires a **Standard** or **Professional** license.

5.2.1.4 Summary

The **Load Case (LCase)** component accepts one or more loads (**PointL**, **SurfaceL**, **LineL**, **DistL**). It outputs a **Load Case**. Several Load Cases can be combined and used as input into the **Problem Specification (ProbSpec)**.

For an example of a Peregrine problem containing multiple load cases, run the [ProbSpec_MultipleLoadCases2.gh](#) file.

5.2.1.5 Input / Output

Input / Output	Description	Default Value
PointL (in)	A load applied at a specified point.	N/A
SurfaceL (in)	Loading applied to a meshable surface structure.	N/A
LineL (in)	Loading applied over the length of a line.	N/A
DistL (in)	Define a distributed load (for use with Grillages).	N/A
Load Case (out)	A load or group of loads to be applied to the structure as an independent case.	N/A

5.2.2 Line Load (LineL)

5.2.2.1 Icon

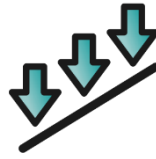

Figure 25 - The Line Load (LineL) icon

5.2.2.2 Component



Figure 26 - The Line Load (LineL) component

5.2.2.3 Description

Loading applied over the length of a line.

5.2.2.4 Summary

The **Line Load (LineL)** component accepts a **LineStruct** as the definition of its geometry and either a force in kN per unit length (**DistF**) or a total force in kN (**TotF**) to define the magnitude of the load imparted. The output is a loaded line (**LineL**).

For an example of a Peregrine problem containing a line load, run the [Structure_LineStruct.gh](#) file.

5.2.2.5 Input/Output

Input / Output	Description	Default Value
LineStruct (in)	A line or line-based structure. An object for loading or to represent a pre-existing structural component that can be utilized within the optimization process.	N/A
DistF (in)	Force per unit length of line (kN/document unit).	(0, 0, 0)
TotF (in)	Total force applied to the line (kN) (will be uniformly distributed).	(0, 0, 0)
LineL (out)	Loading applied over the length of a line.	N/A

5.2.3 Surface Load (SurfaceL)

5.2.3.1 Icon



Figure 27 - The Surface Load (SurfaceL) icon

5.2.3.2 Component

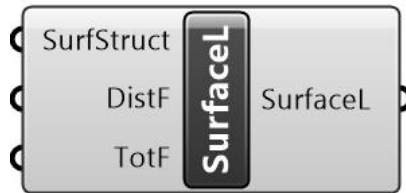

Figure 28 - The Surface Load (SurfaceL) component

5.2.3.3 Description

Loading applied to a meshable surface structure.

5.2.3.4 Summary

The **SurfaceL** component is used as input into a **Load Case**. It accepts a **Surface Structure (SurfStruct)** and either a either a force in kN per unit area (**DistF**) or a total force in kN (**TotF**) to define the magnitude of the load imparted. The output is a **Surface Load (SurfaceL)**.

For an example of a Peregrine problem containing a surface load, run the [Structure_SurfStruct.gh](#) file.

5.2.3.5 Input/Output

Input / Output	Description	Default Value
SurfStruct (in)	A surface structure described by a mesh and having properties used in structural analysis. An object on to which loads are applied or to use as support.	N/A
DistF (in)	Force per unit area of surface (kN/document area unit).	0
TotF (in)	Total force (kN) applied over the surface (distributed evenly)	0
LineL (out)	Loading applied to a meshable surface structure.	N/A

5.2.4 Distributed Load (DistL)

5.2.4.1 Icon



Figure 29 – The Distributed Load (DistL) icon

5.2.4.2 Component



Figure 30 – The Distributed Load (DistL) component

5.2.4.3 Description

Define a distributed load (for use with Grillages).

5.2.4.4 Summary

The **DistL** component divides a given pressure between the nodes that are generated for a given 2D domain. It accepts a **Mesh** as the definition of the area over which to apply the loading and a total magnitude (**Mag**) as the pressure in kN per unit area. The output is a loaded area (**DistL**) that can be used as input for a **Load Case**.

Note - in order to properly function, the input **Mesh** must correspond exactly to a mesh that is used to define a 2D domain within the problem.

For an example of a Peregrine problem containing a distributed load, run the [Grillage_DistributedLoad.gh](#) file. Note that analysis of problems involving Grillages requires a Professional license.

5.2.4.5 Input / Output

Input / Output	Description	Default Value
Mesh (in)	A mesh defining the region over which the load is applied. Note that this must match an existing mesh in the Design Domain	N/A
Mag (in)	The load to apply over the mesh (kN/document area unit)	0
DistL (out)	Define a distributed load (for use with Grillages).	N/A

5.2.5 Point Load (PointL)

5.2.5.1 Icon



Figure 31 – The Point Load (PointL) icon

5.2.5.2 Component



Figure 32 – The Point Load (PointL) component

5.2.5.3 Description

A load applied at a specified point.

5.2.5.4 Summary

The **PointL** component is used as input into a **Load Case**. It accepts {xyz} coordinates in Cartesian space (**Pos**) and a magnitude (**Mag**) in kN. The output is a Point Load (**PointL**).

For an example of a Peregrine problem containing a point load, run the [Simple2D.gh](#) file.

5.2.5.5 Input/Output

Input / Output	Description	Default Value
Pos (in)	A location in Cartesian space, defined using a Construct Point	N/A
Mag (in)	A vector describing the magnitude and direction of the applied force (kN).	(0, 0, 0)
PointL (out)	A load applied at a specified point.	N/A

5.3 Support

5.3.1 Supports

5.3.1.1 Icon



Figure 33 - The Supports icon

5.3.1.2 Component

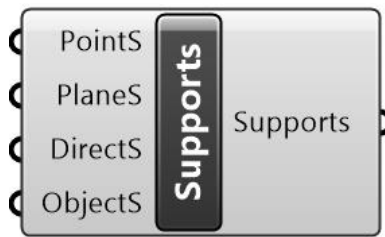

Figure 34 - The Supports component

5.3.1.3 Description

A set of one or more Support definitions.

5.3.1.4 Summary

The **Supports** component accepts one or more support objects (**PointS**, **PlaneS**, **DirectionalS** or **ObjectS**), combines them and outputs them as **Supports** that can then be used as input into the **Design Domain (Domain)**.

Refer to the individual support type descriptions for example files.

5.3.1.5 Input / Output

Input / Output	Description	Default Value
PointS (in)	Restrict translation at specified point(s) in one or more Cartesian directions.	N/A
PlaneS (in)	Provide support across a planar surface or face.	N/A
DirectS (in)	Restrict translation at specified point(s) along a specified vector.	N/A
ObjectS (in)	Support provided by a specified object	N/A

Supports (out)	A set of one or more Support definitions.	N/A
-----------------------	---	-----

5.3.2 Point Support (PointS)

5.3.2.1 Icon



Figure 35 – The Point Support (PointS) icon

5.3.2.2 Component

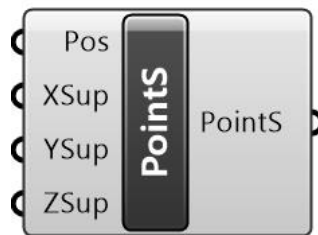

Figure 36 – The Point Support (PointS) component

5.3.2.3 Description

Restrict translation at specified point(s) in one or more Cartesian directions.

5.3.2.4 Summary

The **PointS** component is used as input into **Supports**. It accepts a **Construct Point (Pt)** for its position and a toggle (Boolean operator) to specify whether support is provided at the location in the X, Y or Z direction. By default, all three directions are provided with support (**True**), thus the user only need add extra controls if they wish to allow freedom of movement in one of the directions. The output is a **Point Support (PointS)**.

For an example of a Peregrine problem containing a line load, run the [Simple2D.gh](#) file.

5.3.2.5 Input / Output

Input / Output	Description	Default Value
Pos (in)	A location in Cartesian space, defined using a Construct Point	N/A
XSup (in)	Provide restraint against movement in the X direction	True

5 - Component Reference

YSup (in)	Provide restraint against movement in the Y direction	True
ZSup (in)	Provide restraint against movement in the Z direction	True
PointS (out)	Restrict translation at specified point(s) in one or more Cartesian directions.	N/A

5.3.3 Plane Support (PlaneS)

5.3.3.1 Icon



Figure 37 – The Plane Support (PlaneS) icon

5.3.3.2 Component

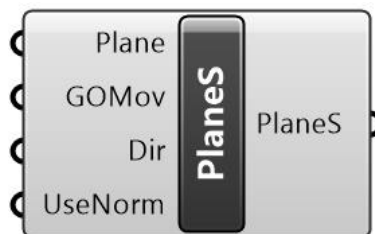

Figure 38 – The Plane Support (PlaneS) component

5.3.3.3 Description

Provide support across a planar surface or face.

5.3.3.4 Summary

The **PlaneS** component is used to specify plane or face support surfaces to be used as input into **Supports**. It accepts a **Plane** (e.g. **XY**) and a number of options to specify how the nodes on the surface behave.

The **Move** (**GOMov**) input is a Boolean toggle (*False* by default) to specify whether the nodes that lie on the surface of the supported plane (i.e. the points of support) are allowed to move around that plane during any Geometry Optimization stage(s).

The **Support Direction(s)** (**Dir**) input is a vector specifying the direction of support at the plane.

The **Use Plane Normal Support** (**UseNorm**) input is a Boolean toggle (*False* by default) to specify whether support is provided to the plane in the normal (perpendicular) direction.

The output is a **Plane Support (PlaneS)**.

For an example of a Peregrine problem containing a plane support, run the [SolutionViewer_Symmetry1.gh](#) file.

5.3.3.5 Input / Output

Input / Output	Description	Default Value
Plane (in)	Planar surface to which support is to be provided.	N/A
GOMov (in)	Allow nodes to move on the plane during Geometry Optimization.	False
Dir (in)	A vector specifying the direction of support at the plane.	N/A
UseNorm (in)	Specify whether support is provided to the plane in the normal (perpendicular) direction.	False
PlaneS (out)	Provide support across a planar surface or face.	N/A

5.3.4 Plane SupportXYZ (PlaneSXYZ)

5.3.4.1 Icon



Figure 39 - The Plane SupportXYZ (PlaneSXYZ) icon

5.3.4.2 Component

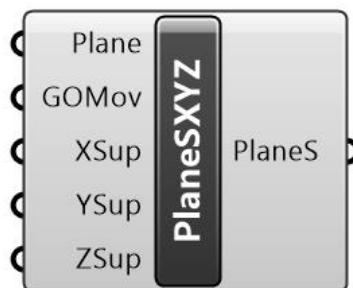

Figure 40 - The Plane SupportXYZ (PlaneSXYZ) component

5.3.4.3 Description

Provide support across a planar surface or face.

5.3.4.4 Summary

The **PlaneSXYZ** component is similar in nature to the **PlaneS** component. It is used to specify plane or face support surfaces with restraint in one or more of the {xyz} directions, to be used as input into **Supports**. It accepts a **Plane** and a number of options to specify how the nodes on the surface behave.

The **Move (GOMov)** input is a Boolean toggle (*False* by default) to specify whether the nodes that lie on the surface of the supported plane (i.e. the points of support) are allowed to move around that plane during any Geometry Optimization stage(s).

The **X, Y and Z** inputs are Boolean toggles (*True* by default) to specify whether restraint is provided in the direction specified.

The output is a **Plane Support XYZ (PlaneSXYZ)**.

For an example of a Peregrine problem containing a Plane XYZ support, run the [ProbSpec_MultipleLoadCases1.gh](#) file.

5.3.4.5 Input / Output

Input / Output	Description	Default Value
Plane (in)	Planar surface to which support is to be provided.	N/A
GOMov (in)	Allow nodes to move on the plane during Geometry Optimization.	False
XSup (in)	Provide restraint against movement in the X direction.	True
YSup (in)	Provide restraint against movement in the Y direction.	True
ZSup (in)	Provide restraint against movement in the Z direction.	True
PointS (out)	Provide support across a planar surface or face.	N/A

5.3.5 Directional Support (DirectionalS)

5.3.5.1 Icon



Figure 41 – The Directional Support (DirectionalS) icon

5.3.5.2 Component



Figure 42 – The Directional Support (DirectionalS) component

5.3.5.3 Description

Restrict translation at specified point(s) along a specified vector.

5.3.5.4 Summary

The **DirectionalS** component is used to specify support positions with restraint in a particular direction. It is used as input into the **Supports** component. It accepts a list of **Vertices** that describe the support **Positions (Pos)** and a similarly sized list of **Vectors** to describe the **Direction (Dir)** afforded to those positions. Using this component, it is possible to e.g. specify support to the vertices of a pre-defined mesh, in a direction normal to the mesh.

For an example of a Peregrine problem containing a directional support, run the [DirectionalSupport.gh](#) file.

5.3.5.5 Input/Output

Input / Output	Description	Default Value
Pos (in)	Point at which support is to be provided,	N/A
Dir (in)	Direction along which support is to be provided.	N/A
PointS (out)	Restrict translation at specified point(s) along a specified vector.	N/A

5.4 Domain

5.4.1 Design Domain (Domain)

5.4.1.1 Icon



Figure 43 - The Design Domain (Domain) icon

5.4.1.2 Component

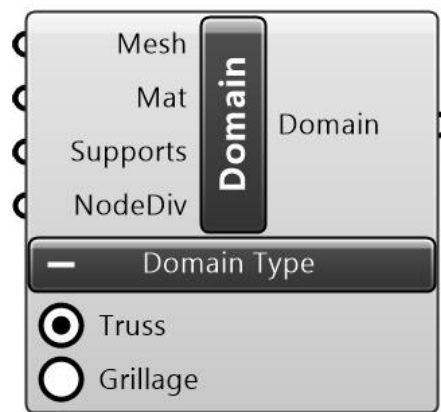

Figure 44 - The Design Domain (Domain) component - Truss

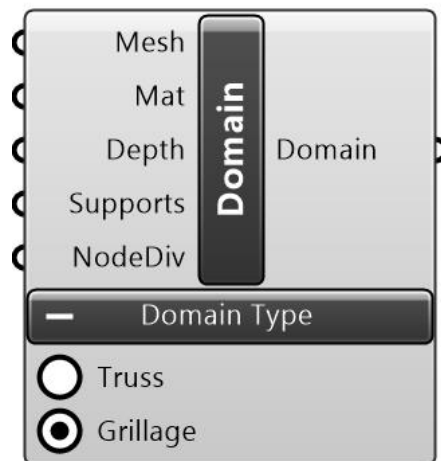

Figure 45 - The Design Domain (Domain) component - Grillage

5.4.1.3 Description

Design domain described by a triangulated mesh.

Notes:

- The number of **Divisions** is limited in **Free** mode such that only problems that are 200 nodes or fewer are solvable.
- Specification of **Grillage** domains cases requires a **Professional** license.
- Specification of **multiple design domains** requires a **Professional** license.

5.4.1.4 Summary

The **Domain** component is used to collate the *Geometry*, *Material* and *Support* data for entry into the **Problem Specification (ProbSpec)**. It is also used to specify the **Domain type** as either a **Truss** or a **Grillage**.

A **Truss** comprises an arrangement of triangulated elements in either a 2D or 3D environment and which works primarily in tension and compression (Figure 45), whereas a **Grillage** comprises a series of interconnected elements over a 2D planar surface with a common structural depth and which works in bending (Figure 47).

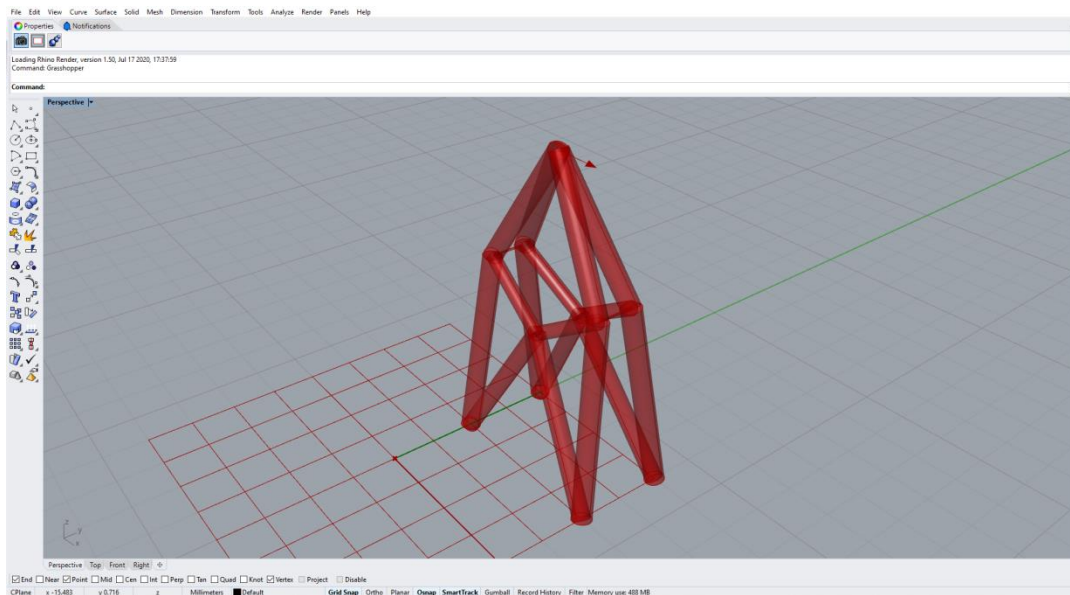

Figure 46 – A (simple) optimized truss structure

5 - Component Reference

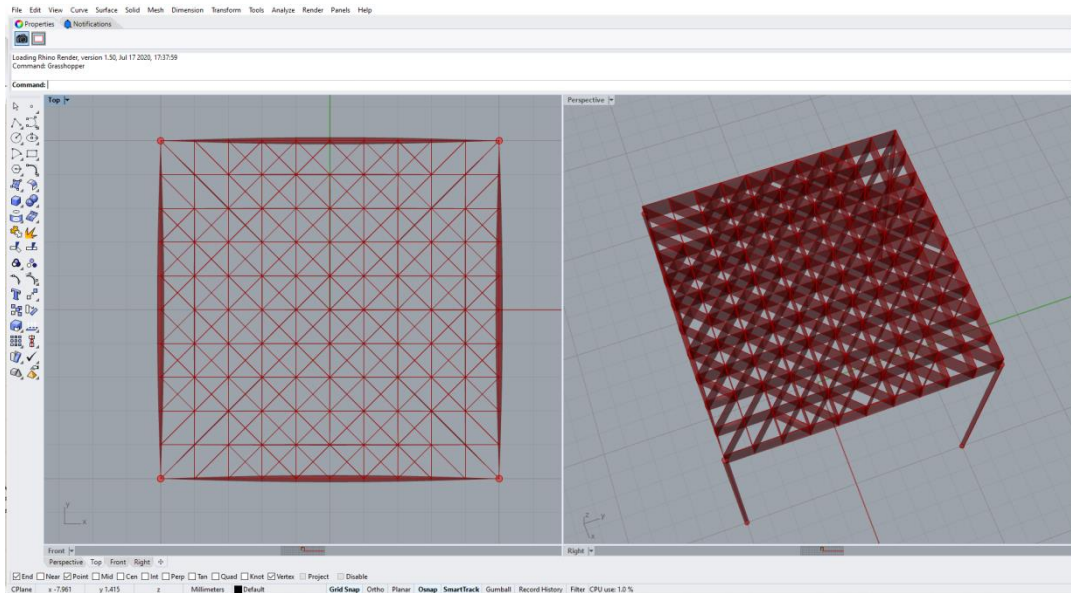

Figure 47 – An example of an optimized grillage structure (supported on four columns)

The **Domain Mesh (Mesh)** input defines the geometry of the Design Domain. It takes a triangulated mesh, which can come from a variety of sources. When the **Domain type** is set to be a **Grillage**, the input mesh must be 2D.

Multiple domains can be specified in a problem. These can be of differing types and each can contain a different material etc. However, all shared geometries between any two domains (i.e. interfaces) must be entire faces, entire edges or singular points. Partial overlaps, whether in 2D or 3D, are not permitted (see Figure 48):

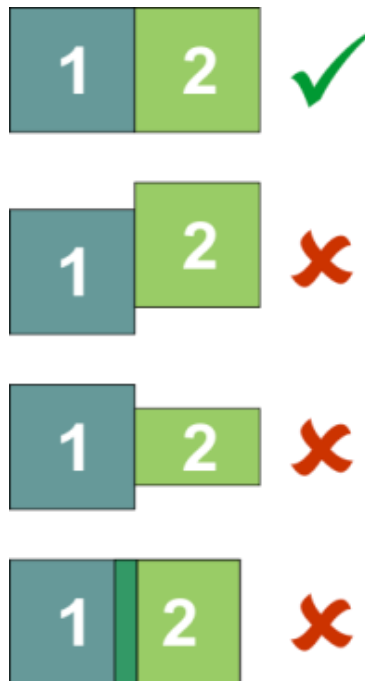

Figure 48 – Allowable mesh interfacing configurations

The **Material (Mat)** input accepts a user-defined set of material properties from a **Mat** component.

The **Depth (Depth)** is an input that is only associated with the **Grillage** type. It specifies the structural depth of all grillage elements within the **Domain**. Note that grillages are able to transmit infinite forces in-plane (i.e. they are assumed to be rigid in-plane).

The **Supports** input accepts a collection of supports from a **Supports** component.

The **Nodal Division (NodeDiv)** input accepts a number and defines the density of nodes assigned to the problem. It identifies and divides the diagonal of the design bounding box into the specified number of divisions and sets up a regular nodal grid in all three directions based upon this. Note that many post-processing steps use the **NodeDiv** setting to determine suitable limits on e.g. the movement of nodes during geometry optimization. Therefore, a suitable value should be provided, even if user-defined nodes are being provided for the main optimization.

The output is a **Domain**.

For an example of a Peregrine problem containing a basic **Truss** domain component, run the [Simple2D.gh](#) file.

For an example of a Peregrine problem containing a basic **Grillage** domain component, run the [Grillage_2PartTable.gh](#) file.

5.4.1.5 Input / Output

Input / Output	Description	Default Value
Mesh (in)	A triangulated mesh defining the geometry of the Design Domain. When the Domain type is set to be a Grillage, the input mesh must be 2D	N/A
Mat (in)	The properties of the material used in this Domain.	N/A
Depth (in)	(Only available for grillage domains). The structural depth of all grillage elements within the Domain. Note that grillages are able to transmit infinite forces in-plane (i.e. they are assumed to be rigid in-plane).	N/A
Supports (in)	A set of one or more support definitions.	True
NodeDiv (in)	Defines the density of nodes assigned to the Domain. Divides the diagonal of the Domain bounding box into the specified number of divisions and sets up a regular Cartesian nodal grid from this.	1

5 - Component Reference

Domain (out)	Design domain described by a triangulated mesh.	N/A
---------------------	---	-----

5.4.2 Design Domain 1D (Domain 1D)

5.4.2.1 Icon



Figure 49 – The Design domain 1D (Domain 1D) icon

5.4.2.2 Component

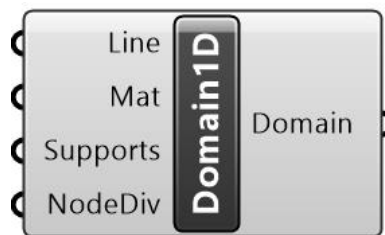

Figure 50 – The Design domain 1D (Domain 1D) component

5.4.2.3 Description

Design domain described by a line.

5.4.2.4 Summary

The **Design domain 1D (Domain 1D)** component is used to define one or more specified areas of design domain where a 1D (line) element can exist e.g. it is useful for specifying the locations of potential columns in a building optimization.

The output is a **Design Domain (Domain)**, which can then form part of the input into the **Problem Specification (ProbSpec)** component.

For an example of a Peregrine problem containing a **Domain 1D** component, run the [Grillage_2PartTable.gh](#) file.

5.4.2.5 Input / Output

Input / Output	Description	Default Value
Line (in)	Line(s) defining the geometry of the design Domain.	N/A

5 - Component Reference

Mat (in)	The properties of the material used in this Domain.	True
Supports (in)	A set of one or more support definitions.	True
NodeDiv (in)	Defines the density of nodes assigned to the Domain. Divides the length of the Domain line by the specified number of divisions and sets up a regular Cartesian nodal array from this.	True
Domain (out)	Design domain described by a line.	N/A

5.4.3 Material (Mat)

5.4.3.1 Icon



Figure 51 - The Material (Mat) icon

5.4.3.2 Component

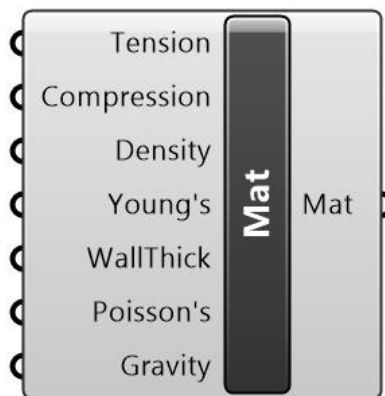

Figure 52 - The Material (Mat) component

5.4.3.3 Description

The properties of the material used in this Domain.

5.4.3.4 Summary

The **Material (Mat)** component is used to define all the material properties for the problem. These are used by the optimization and analysis algorithms. Note that the magnitude of the

5 - Component Reference

Wall Thickness Ratio (WallThick) parameter allows users to specify whether e.g. the members are CHS or CSS as well as influencing Euler buckling calculations.

The output is a **Material (Mat)**, which is then used as an input for a **Design Domain (Domain)** component.

For an example of a Peregrine problem containing a **Material** component, run the [Simple2D.gh](#) file.

5.4.3.5 Input / Output

Input / Output	Description	Default Value
Tension (in)	Limiting (maximum) tensile stress (MPa).	350
Compression (in)	Limiting (maximum) compressive stress (MPa).	350
Density (in)	Material density (kg/m ³).	7800
Young's (in)	Young's modulus (GPa).	210
WallThick (In)	Ratio of wall thickness to member radius (>0.0 to 1.0). Default = 0.1. Note that assigning a value of 1.0 will set the section to be solid.	0.1
Poisson's (In)	Poisson's ratio.	0.3
Gravity (in)	Body force acceleration (m/s ²) in the Cartesian directions. For example (0, 0, -9.81) applies structural self-weight in the downwards Z direction.	(0, 0, 0)
Mat (out)	The properties of the material used in this Domain.	N/A

5.5 Solve

5.5.1 Problem Specification (ProbSpec)

5.5.1.1 Icon



Figure 53 – The Problem Specification (ProbSpec) icon

5.5.1.2 Component

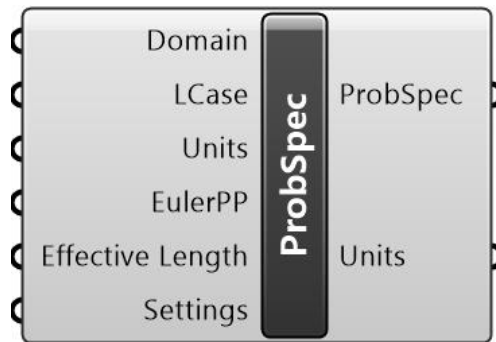

Figure 54 – The Problem Specification (ProbSpec) component

5.5.1.3 Description

Problem specification

5.5.1.4 Summary

The **Problem Specification (ProbSpec)** component combines one or more **Domain(s)** and the applied **Loading** for input into the **Layout Optimization** component. The **Units** of the problem are also input here. The output is a **Problem (ProbSpec)** and the **Units** of the problem.

For an example of a Peregrine problem containing the **ProbSpec** component, run the [Simple2D.gh](#) file.

5.5.1.5 Input/Output

Input / Output	Description	Default Value
Domain (in)	Design domain(s)	False
LCase (in)	A load or group of loads to be applied to the structure as an independent case.	N/A

5 - Component Reference

Units (in)	<p>Defines the units of length used for geometrical measures defined in Grasshopper. If nothing is specified, the Rhino units of length are assumed by default.</p> <p>Permissible values: mm, cm, m, km, in, ft</p> <p>Note that other units used by Peregrine and incorporating length (allowable stress, pressure etc.) are not modified when changing this input and may need to be updated manually.</p>	Rhino units
EulerPP (in)	<p>Consider Euler buckling as part of post process stages. Note that this differs to Euler buckling when considered as part of the layout optimization stage.</p>	0
Effective Length (in)	<p>Multiplier on the length of the member required to cause it to buckle as 'pinned - pinned'.</p>	1.0
Settings (in)	<p>General settings applied in this problem.</p>	N/A
Vol (out)	<p>Volume of the solution structure.</p>	N/A
Lines (out)	<p>The optimum structure represented by line elements.</p>	N/A
ProbSpec (out)	<p>Problem specification for use in LO or ConstructTopology</p>	N/A
Units (out)	<p>Units used in Grasshopper.</p>	N/A

5.5.2 Layout Optimization (LO)

5.5.2.1 Icon



Figure 55 - The Layout Optimization icon

5.5.2.2 Component

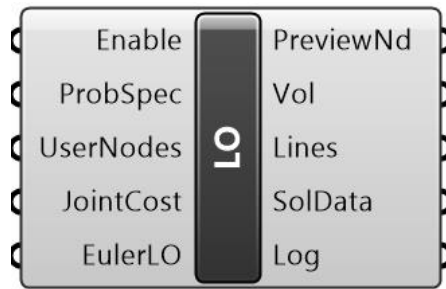

Figure 56 – The Layout Optimization component

5.5.2.3 Description

Solve layout optimization problem.

5.5.2.4 Summary

The **Layout Optimization** component takes the problem input, conducts an optimization and presents the output in a number of formats.

Optimization is toggled on or off using the **Enable** function. When enabled, the **Layout Optimization** takes the **Problem Specification (ProbSpec)** and performs a linear programming layout optimization on it (see Section 6.1.1 for more details).

While the nodal discretization within the problem is generally defined as part of setting up the **Design Domain**, one can override this in the **Layout Optimization** by providing a list of nodes at specific positions via the **User Nodes (UserNodes)** input. For an example of a Peregrine problem containing **User Nodes**, run the [LO_UserNodes.gh](#) file

By specifying a **Joint Cost (JointCost)**, the solver will add a penalty to elements in the optimum layout (in the form of a fictional additional length). This may in some cases help to generate simpler layouts with reduced complexity (as fewer elements mean a lower total penalization). However, the volume will be increased as a result. By specifying a number of **Joint Costs** as input, a number of different solutions can be found. More about **Joint Costs** in the layout optimization formulation is provided in Section 6.1.3. For an example of a Peregrine problem containing **Joint Costs**, run the [LO_JointCost.gh](#) file.

The output from the **Layout Optimization** component relates to the problem and optimum **Solution (Sol)**:

With Euler buckling layout optimization (**EulerLO**) enabled, the solver will attempt to ensure stability against Euler buckling as part of the optimization process. Note that this requires an appropriate **Effective Length** to be specified in the **Problem Specification (ProbSpec)**. The process makes use of a heuristic approach and, as such, is not guaranteed to be successful in all situations.

An example comparing Euler buckling as post-process and in-optimization steps is provided in [Euler_buckling.gh](#)

The **Volume (Vol)** output supplies the volume (mm³) of the optimum structure at the end of the optimization stage.

The **Topology** output delivers a representation of the optimum structure as line elements.

The **Solution (Sol)** output packages together all the required data relating to the optimization problem and optimal, least volume, structure in a form that can be used as input into the **PostProcess** stages or displayed within the Rhino environment.

The **Solution Log (Log)** output can be connected to e.g. a **Panel** in order to display information relating to the **Layout Optimization** iterations (Iteration Number, Nodes, Members and Volume).

For an example of a Peregrine problem containing an **Layout Optimization** component, run the [Simple2D.gh](#) file

5.5.2.5 Input / Output

Input / Output	Description	Default Value
Enable (in)	Enable this component.	False
ProbSpec (in)	A combination of one or more Domain(s) and Load Case(s) for input into the Layout Optimization (LO) .	N/A
UserNodes (in)	A set of user-defined nodal positions to use as potential member end points during optimization. Note that the NodeDiv input for Domain and Domain1D will not be used for the purposes of structural layout, but may still be used when calculating other analysis parameters (e.g. tolerances).	N/A
JointCost (in)	a Boolean to specify whether the point is restrained against movement in the Z direction object	0
EulerLO (in)	Consider Euler buckling as part of the layout optimization. Slender members will be identified and suppressed during optimization, rather than as a post-process step.	False
PreviewNd (out)	Preview the nodes that are used in the layout optimization.	N/A
Vol (out)	Volume of the solution structure.	N/A

5 - Component Reference

Lines (out)	The optimum structure represented by line elements.	N/A
SolData (out)	Optimization solution data.	N/A
Log (out)	Solution log.	N/A

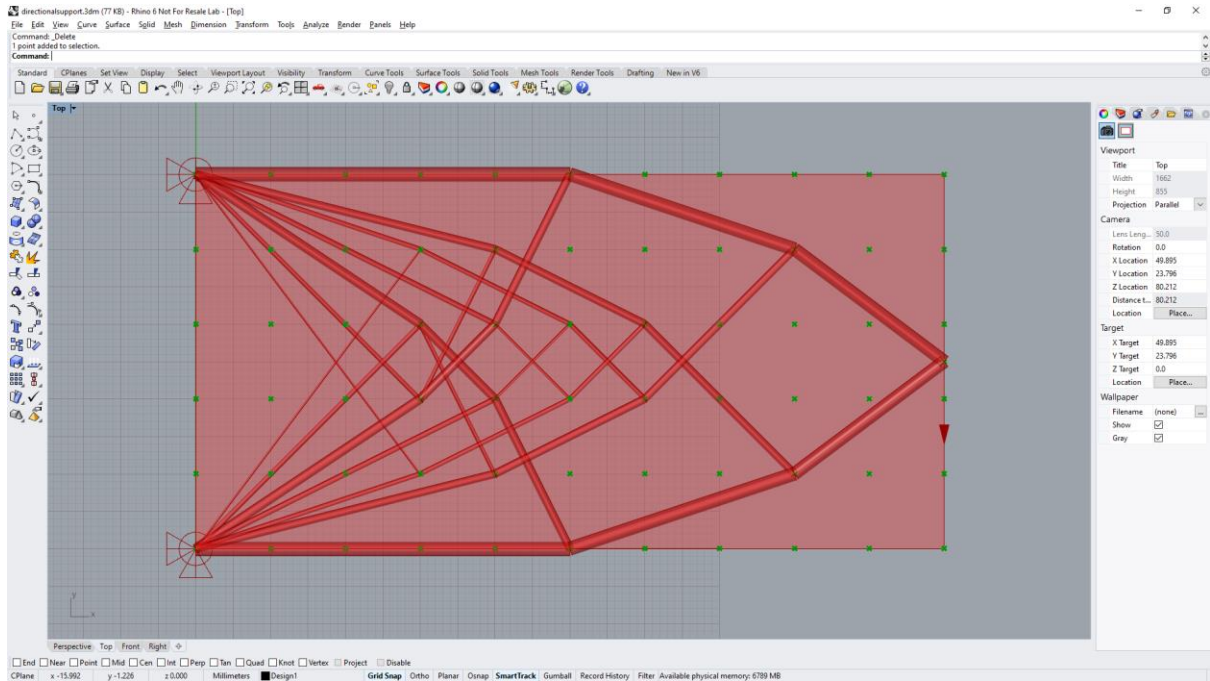

Figure 57 – The Simple2D problem in Rhino. Nodes previewed in green

5.6 PostProcess

5.6.1 Geometry Optimization (GO)

5.6.1.1 Icon

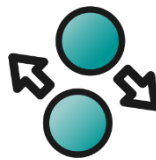

Figure 58 – The Geometry Optimization (GO) icon

5.6.1.2 Component



Figure 59 – The Geometry Optimization (GO) component

5.6.1.3 Description

Geometry Optimization.

5.6.1.4 Summary

The **Geometry Optimization (GO)** component undertakes a geometry optimization on the output from a previous optimization or simplify operation (**Sol**) by moving the positions of joints to more favorable positions (i.e. positions that will lead to a lower structural volume). As part of this process, the structure may be automatically converted from a pin-jointed representation (no moment resistance at joints) to a frame representation (moment resistance at joints).

The **Maximum Number of Input Nodes Allowed (Limit)** is an integer describing the upper limit on the number of nodes that are allowed in a structure that is to undergo **Geometry Optimization**. If the input **Solution (Sol)** contains more nodes than this value, a warning will be shown. By default, the limit is set to 100.

The **Maximum Number of Iterations (Iter)** is an integer that sets the number of geometry optimization iterations that are allowed to take place before the solution is returned. If convergence occurs before this value is hit, the geometry optimization will be curtailed. By default, the limit is set to 5.

The **Volume (Vol)** is a measure of the volume of the structure post-geometry-optimization.

The **Solution (Sol)** output packages together all the required data relating to the optimization problem and optimal structure in a form that can be used as input into further **PostProcess** stages or displayed within the Rhino environment using the **SolutionViewer**.

The **Solution Log (Log)** can be connected to e.g. a **Panel** in order to display information relating to the **LO** iterations (Iteration Number, Nodes, Members and Volume).

For an example of a Peregrine problem containing **GO** component, run the [PostProcess_GO.gh](#) file.

5.6.1.5 Input/Output

Input / Output	Description	Default Value
SolData (in)	Optimization solution data.	N/A
MaxJoints (in)	The maximum number of joints allowed in the input structure.	100
MaxIters (in)	The maximum number of geometry optimization iterations.	5
Vol (out)	Volume of the solution structure.	True
SolData (out)	Geometry optimization solution data.	N/A
Log (out)	Solution log.	N/A

5.6.1.6 Example

An example of the **Geometry Optimization** process is shown in Figure 60:

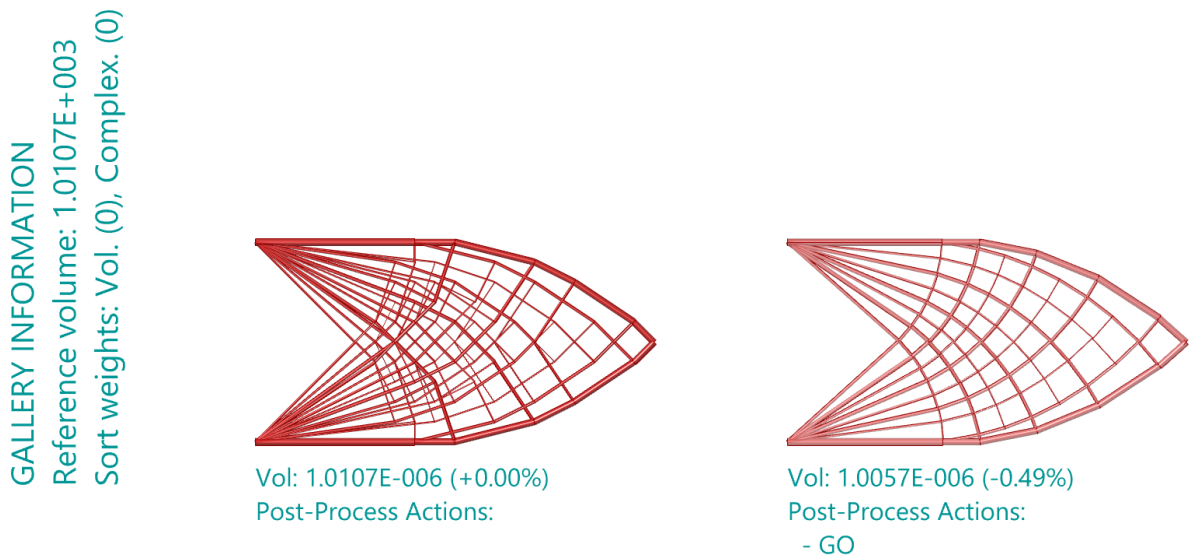

Figure 60 - The GO component used to reduce the complexity of a solution

5.6.2 Simplify (Simplify)

5.6.2.1 Icon



Figure 61 - The Simplification icon

5.6.2.2 Component

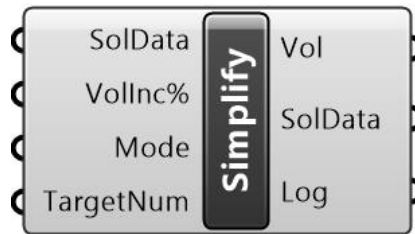

Figure 62 - The Simplify component

5.6.2.3 Description

Simplify using smooth Heaviside function

5.6.2.4 Summary

The **Simplify** component takes the output (**Sol**) from an optimization and attempts to reduce the number of elements that connect at the joints.

The user specifies a permissible **Volume Increase (Vollnc%)** in the volume of the structure that can be traded for this reduced complexity. A smooth Heaviside formulation is used to e.g., reduce the number of elements, while still possessing a volume that is below the permissible value.

Additionally, the user may specify the **Simplification Mode (Mode)** with an integer, used to select from one of three options that define the method used to simplify the input structure. These are:

1. **All members** - seeks to reduce the total number of members in the structure while keeping the volume within the specified percentage of volume increase (**Vollnc%**)
2. **Joint complexity** - examines each joint within the optimum structure and attempts to reduce the number of elements meeting towards the specified value (**Num**), while keeping the volume within the specified percentage of volume increase (**Vollnc%**)
3. **Most complex joint** - examines the most complex joint within the optimum structure and attempts to reduce the number of elements meeting at it towards the specified value

(**Num**), while keeping the volume within the specified percentage of volume increase (**Vollnc%**)

The **Target # members (TargetNum)** input

The **Volume (Vol)** is a measure of the volume of the structure post-simplification.

The **Solution (Sol)** output packages together all the required data relating to the optimization problem and optimal structure in a form that can be used as input into further **PostProcess** stages or displayed within the Rhino environment using the **SolutionViewer**.

The **Solution Log (Log)** can be connected to e.g. a **Panel** in order to display information relating to the **LO** iterations (Iteration Number, Nodes, Members and Volume).

Note that, if a simplification step is unable to complete, or has no effect on the solution, a warning message will be given by the component to alert the user to this fact. The output from the component will be the same as the input (allowing downstream actions to still occur).

5.6.2.5 Input / Output

Input / Output	Description	Default Value
SolData (in)	Optimization solution data.	N/A
Vollnc% (in)	The volume of the structure (as a %) that can be traded for reduced complexity.	5
Mode (in)	"The type of simplification to perform: 1) Reduce # members overall 2) Reduce # members at all joints 3) Reduce # members at the most complex joint(s). In each case, the simplification will try to keep the volume within the specified allowable increase (Vollnc%). In modes 2 and 3, joint(s) will considered 'complex' if they contain more than TargetNum converging members.	1
TargetNum (in)	In applicable simplification modes, joint(s) will considered 'complex' if they contain more than TargetNum converging members.	4
Vol (out)	Volume of the solution structure.	N/A
SolData (out)	Optimization solution data.	N/A
Log (out)	Solution log.	N/A

5 - Component Reference

5.6.2.6 Example

Please note that the **Simplify** component can sometimes produce truss configurations that are asymmetrical, despite having a symmetrical problem definition. This can generally be addressed by passing the output through a **Geometry Optimization (GO)** component and increasing the **Iteration (Iter)** count as necessary. For an example of a problem containing a **Simplify** component, see the [PostProcess_SimplificationJointComplexity.gh](#) file.

5.6.2.7 Example

An example of the **Simplify** process is shown in Figure 63:

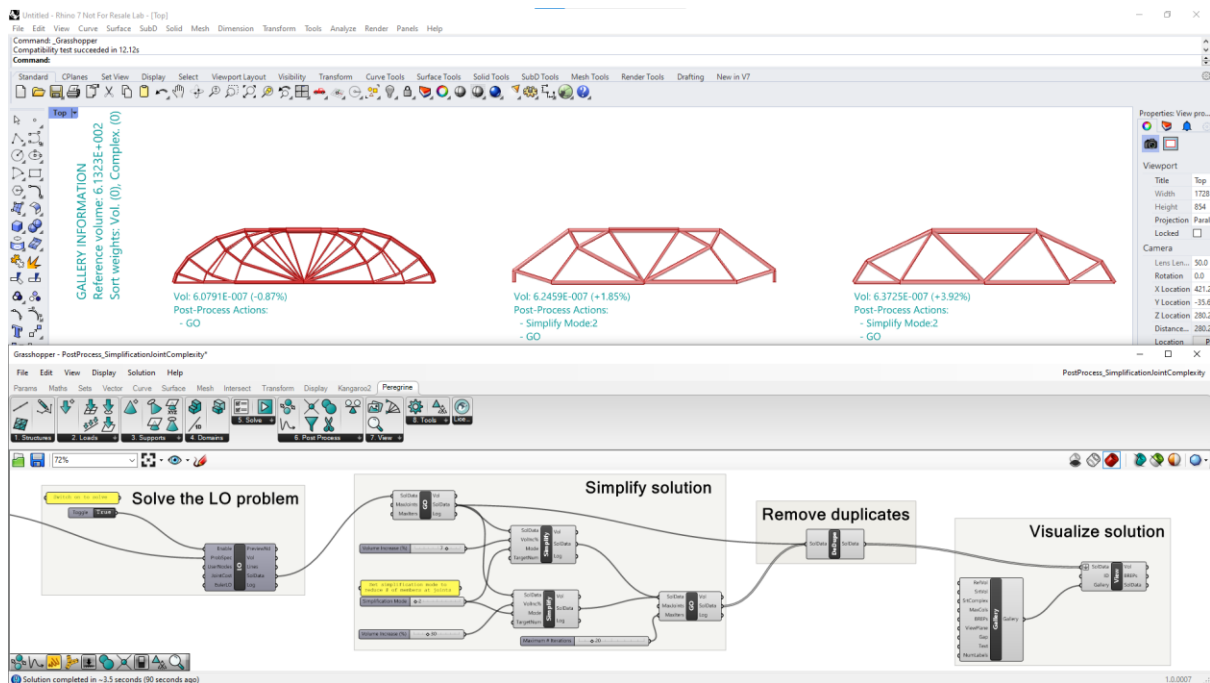

Figure 63 – Simplification of a truss structure

5.6.3 Crossovers (Crossovers)

5.6.3.1 Icon

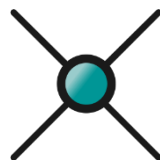

Figure 64 – The Crossovers icon

5.6.3.2 Component

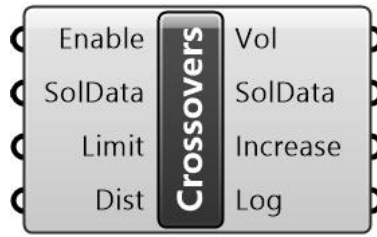

Figure 65 - The Crossovers component

5.6.3.3 Description

Create crossover nodes.

5.6.3.4 Summary

Occasionally, generally as a result of geometry optimization, elements can be found that overlap, but do not have a node at the overlap location. The **Crossovers (Crossover)** component takes the output (**Sol**) from an optimization and introduces nodes where these elements cross each other.

The user specifies a permissible **Volume Increase Limit (Limit)** (default of 100%). Above this value, the crossovers will not be generated.

The **Crossover Distance Ratio (Dist)** is a measure of the proximity of members below which a crossover will be created. The longest diagonal of the model bounding box is determined and the ratio value is the percentage of this measure which is used as the “search area” for crossovers. For example, in a 3D model with a 100mm bounding box, a value of “*Dist=1*” will ensure that elements with center lines that pass within 1mm of each other are checked and a crossover node added if required.

The **Enable** input is connected to a toggle, to allow the selective enabling and disabling of this component functionality. If changes are to be made to the **Limit** or **Dist** inputs, it is recommended that the component is left disabled while this is done.

The **Volume (Vol)** is a measure of the volume of the structure post-modification.

The **Solution (Sol)** output packages together all the required data relating to the optimization problem and optimal structure in a form that can be used as input into further **PostProcess** stages or displayed within the Rhino environment using the **SolutionViewer**. It is generally recommended that a **GO** step is undertaken after crossovers are created.

The **Volume Increase (Increase)** output is a measure of the increase in structural volume encountered as a result of the crossovers functionality being undertaken.

The **Solution Log (Log)** can be connected to e.g. a **Panel** in order to display information relating to the component actions.

5 - Component Reference

For an example of a Peregrine problem containing the **Crossovers** component, run the [PostProcess_Crossover.gh](#) file.

5.6.3.5 Example

An example of the **Crossovers** process is shown in Figure 66:

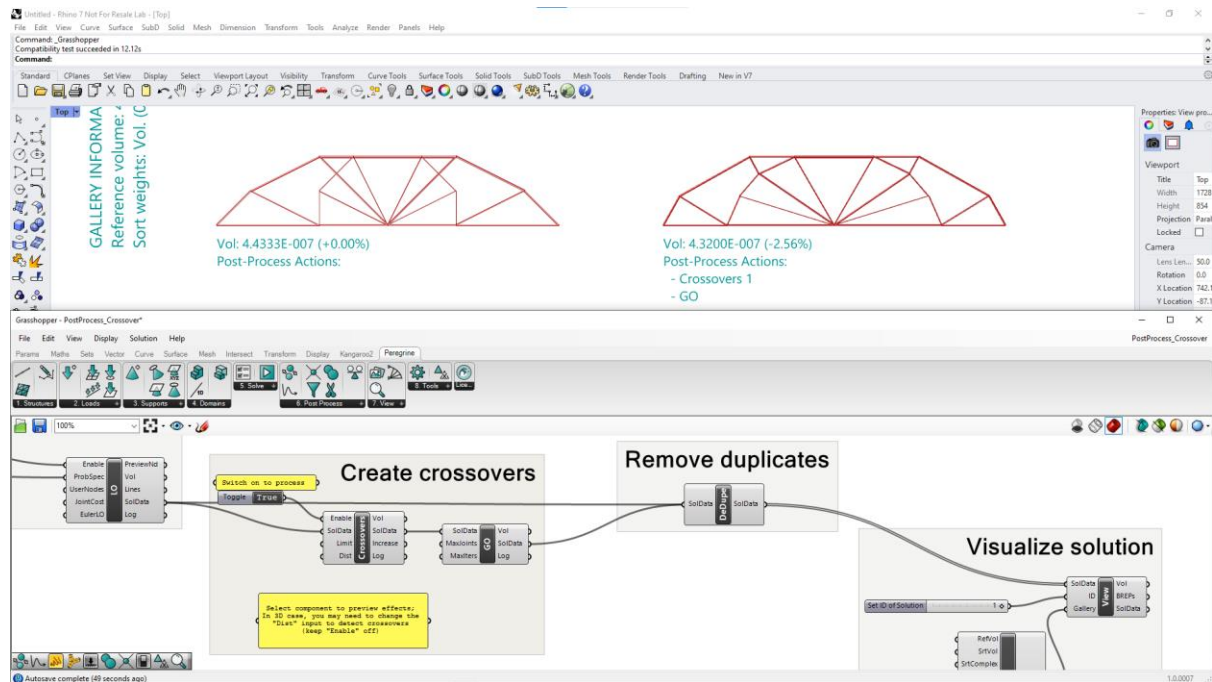

Figure 66 – An example of the output of the crossovers functionality

Here, the leftmost solution is the result of a normal **LO** step. **Crossovers** are created in the center image (note that the volume remains unchanged) and the resulting structure passed to the **GO** component, which moves joints to more optimal positions.

5.6.3.6 Input/Output

Input / Output	Description	Default Value
SolData (in)	Optimization solution data.	N/A
Limit (in)	Limit in solution volume percentage increase. Above this value, the solution offered by this component will be rejected	100
Dist (in)	Measure of the proximity of members, below which a crossover will be created. The longest diagonal of the model bounding box is determined and the proximity is the percentage of this measure which is used as the “search area” for crossovers.	1

5 - Component Reference

Vol (out)	Volume of the solution structure.	N/A
SolData (out)	Optimization solution data.	N/A
Increase (out)	Volume increase (%).	N/A
Log (out)	Solution log.	N/A

5.6.4 Filter (Filter)

5.6.4.1 Icon



Figure 67 - The Filter icon

5.6.4.2 Component

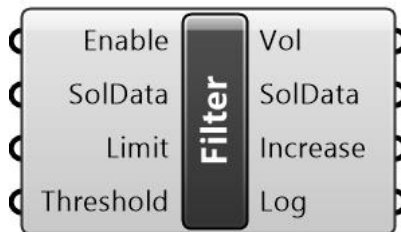

Figure 68 - The Filter component

5.6.4.3 Description

Filter small elements (and may also reposition nodes to restore equilibrium).

5.6.4.4 Summary

The **Filter** functionality takes a Solution (**Sol**) from an optimization or post-process step and removes the elements with a cross-sectional area below a specified **Filter Threshold % (Threshold)**.

The value of the **Threshold** is a user-specified percentage of the cross-sectional area of the largest element that exists in the solution. The component will attempt to remove elements with cross-sections below that which this relates to.

By removing elements, the equilibrium of forces at nodes will naturally be compromised to some extent. The Filter function will therefore attempt to also restore equilibrium where necessary, using a geometry optimization step.

The **Volume Increase Limit (Limit)** is the percentage increase in structural volume that is allowed to occur as a result of the **Filter** functionality. By default, the limit is set to 100.

The **Enable** input is connected to a toggle, to allow the selective enabling and disabling of this component functionality. If changes are to be made to the **Limit** or **Threshold** inputs, it is recommended that the component is left disabled while this is done.

For an example of a Peregrine problem containing **Filter** component, run the [PostProcess_Filter.gh](#) file.

5.6.4.5 Input / Output

Input / Output	Description	Default Value
SolData (in)	Optimization solution data.	N/A
Limit (in)	Limit in solution volume percentage increase. Above this value, the solution offered by this component will be rejected	100
Threshold (in)	A percentage of the cross-sectional area of the largest element that exists in the solution. Members with areas below this will be removed where possible.	5
Vol (out)	Volume of the solution structure.	N/A
SolData (out)	Optimization solution data.	N/A
Increase (out)	Volume increase (%).	N/A
Log (out)	Solution log.	N/A

5.6.4.6 Example

An example of the results of a **Filter** stage is shown in Figure 69:

5 - Component Reference

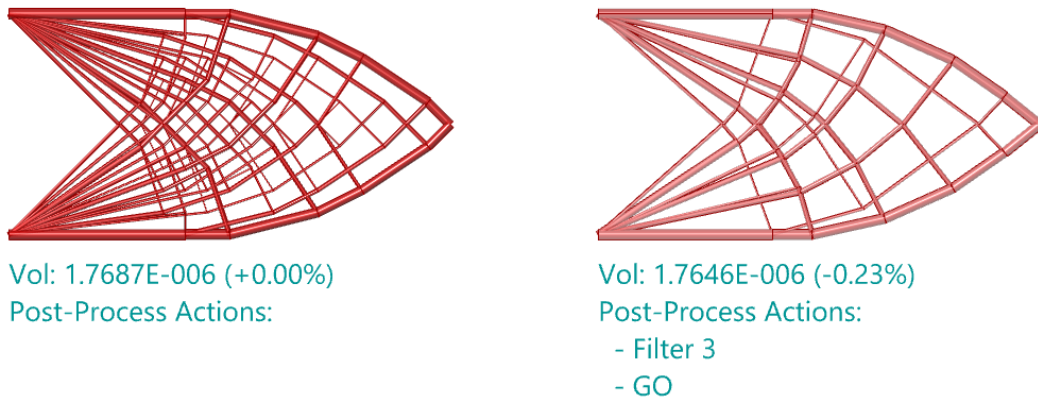

Figure 69 – Filtering the output from Layout Optimization stage (L = original, R = filtered)

On the right is the original solution. On the left is a filtered version, where a filter **Threshold** of 3% has been specified and a **Geometry Optimization** stage carried out after the filter. It can be seen that the resulting structure is both simpler and lower in volume.

5.6.5 Merge Joints (Merge)

5.6.5.1 Icon



Figure 70 – The Merge Joints icon

5.6.5.2 Component

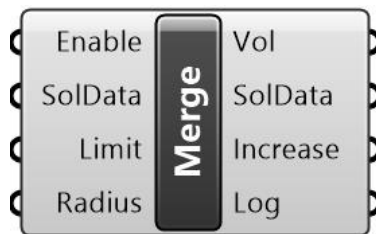

Figure 71 – The Merge Joints component

5.6.5.3 Description

Merge joints

5.6.5.4 Summary

The **Merge Joints (Merge)** functionality accepts a Solution (**Sol**) from an optimization or post-process step and combines nodes (joints) within the structure that lie within a prescribed **Merge Radius Ratio (Radius)**.

The value of the **Radius** (default = 5) is a measure of the proximity of nodes, below which a merge will be attempted. The longest diagonal of the model bounding box is determined and the ratio value is the percentage of this measure which is used as the “search area”. For example, in a model with a 100mm bounding box, a value of “**Radius = 5**” will ensure that nodes which lie within 5mm of each other are checked and an attempt made to merge them.

By removing nodes and elements, the equilibrium of forces may be compromised to some extent. The **Merge** function will therefore attempt to also restore equilibrium where necessary, using a supplementary geometry optimization step.

The **Volume Increase Limit (Limit)** is the percentage increase in structural volume that is allowed to occur as a result of the **Filter** functionality. By default, the limit is set to 100.

The **Enable** input is connected to a toggle, to allow the selective enabling and disabling of this component functionality. If changes are to be made to the **Limit** or **Radius** inputs, it is recommended that the component is left disabled while this is done.

For an example of a Peregrine problem containing **Merge** component, run the [PostProcess_MergeNodes.gh](#) file.

5.6.5.5 Input/Output

Input / Output	Description	Default Value
SolData (in)	Optimization solution data.	N/A
Limit (in)	Limit in solution volume percentage increase. Above this value, the solution offered by this component will be rejected	100
Radius (in)	The distance between joints, below which a merge will be attempted. The longest diagonal of the model bounding box is determined and the Merge Radius is the percentage of this measure to be used as the “search area”.	5
Vol (out)	Volume of the solution structure.	N/A

5 - Component Reference

SolData (out)	Optimization solution data.	N/A
Increase (out)	Volume increase (%).	N/A
Log (out)	Solution log.	N/A

5.6.5.6 Example

An example of the results of a **Merge** stage is shown in Figure 72:

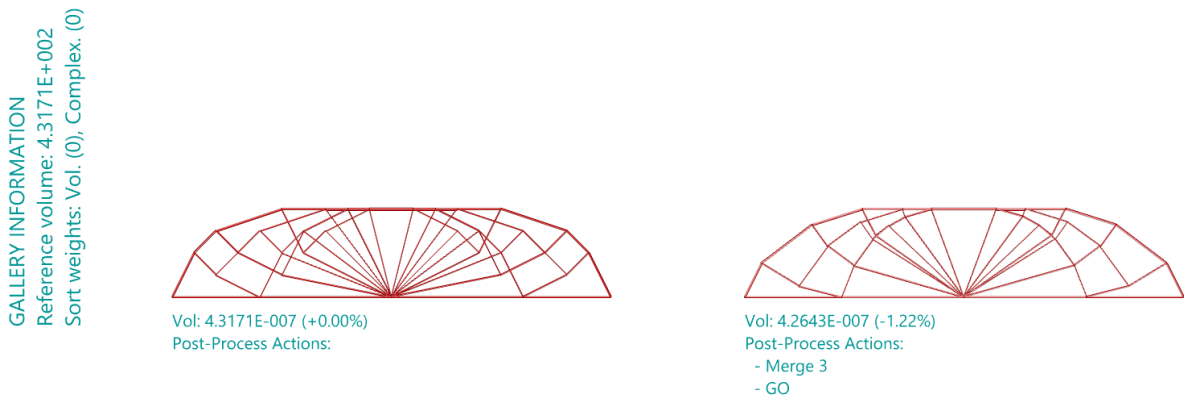

Figure 72 - A node Merge (L = original solution, R = node merge)

5.6.6 Reduce Complexity (Complexity)

5.6.6.1 Icon



Figure 73 - The Reduce Complexity icon

5.6.6.2 Component

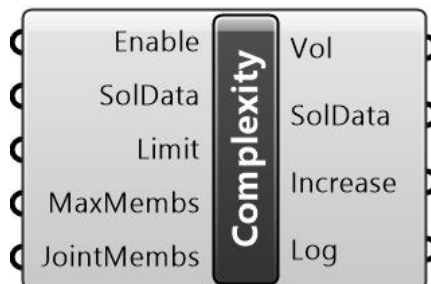

Figure 74 - The Reduce Complexity component

5.6.6.3 Description

Reduce complexity

5.6.6.4 Summary

The **Reduce Complexity (Complexity)** component accepts a Solution (**Sol**) from an optimization or post-process step and attempts to reduce the number of elements according to a user-specified directive on the method used, plus an allowable increase in structural volume.

Note that in general the **Simplify** component, which is based on a different numerical approach, is likely to produce superior results and is therefore recommended for most situations.

The value of the **Maximum number of members at joint (BarsAtJoint)** (default = 8) defines the greatest number of members that can join at any one location (joint). The **Complexity** functionality will then attempt to identify the minimum volume structure that conforms to this requirement. By removing nodes and elements, the equilibrium of forces may be compromised to some extent. The **Complexity** function will therefore attempt to also restore equilibrium where necessary, using a supplementary geometry optimization step.

The **Volume Increase Limit (Limit)** is the percentage increase in structural volume that is allowed to occur as a result of the operation of the **Complexity** functionality. By default, the limit is set to 100.

The **Enable** input is connected to a toggle, to allow the selective enabling and disabling of this component functionality. If changes are to be made to the **MaxBars**. or **BarsAtJoint** inputs, it is recommended that the component is left disabled while this is done.

The output is a new optimal **Solution (Sol)** along with data relating to its generation.

For an example of a Peregrine problem containing the **Complexity** component, run the [PostProcess_Complexity.gh](#) file.

5.6.6.5 Input / Output

Input / Output	Description	Default Value
SolData (in)	Optimization solution data.	N/A
Limit (in)	Limit in solution volume percentage increase. Above this value, the solution offered by this component will be rejected	100
MaxMembs (in)	Maximum number of members in the optimum structure.	100

5 - Component Reference

JointMembs (in)	Maximum number of members that can meet at a joint.	8
Vol (out)	Volume of the solution structure.	N/A
SolData (out)	Optimization solution data.	N/A
Increase (out)	Volume increase (%).	N/A
Log (out)	Solution log.	N/A

5.6.6.6 Example

An example of the results of a **Reduce Complexity** stage is shown in Figure 75.

On the right is the original solution. On the left is a modified version, where a complexity threshold of 6 members per node has been specified and a **GO** stage carried out after the filter. It can be seen that the resulting structure is simpler but has a comparable volume.

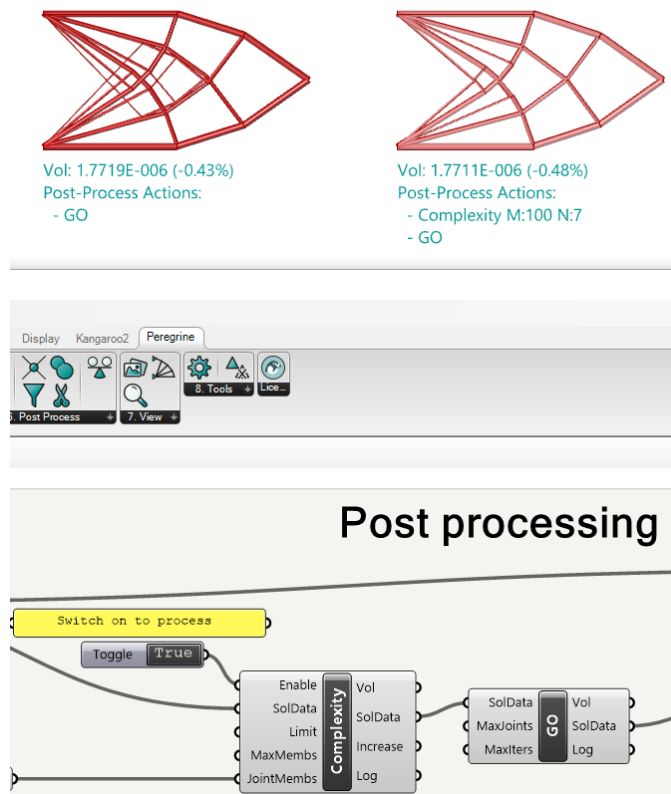

Figure 75 - Reducing the complexity of the solution (left = original, right = refined)

5.6.7 Stabilize (Stabilize)

5.6.7.1 Icon



Figure 76 - The Stabilize icon

5.6.7.2 Component

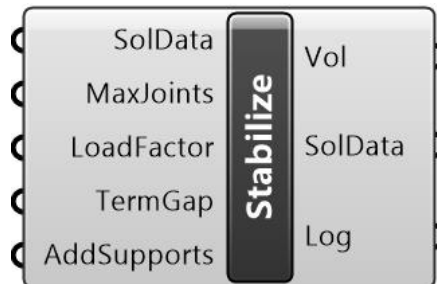

Figure 77 - The Stabilize component

5.6.7.3 Description

Stabilize a structure for global stability.

Note:

- Use of the Stabilize component requires a **Professional** license.

5.6.7.4 Summary

The **Stabilize (Stabilize)** component accepts a Solution (**Sol**) from an optimization, constructed topology or post-process step and, using a semi-definite programming approach, attempts to ensure that the structure is linearly stable under the specified loads.

If the calculated load factor is less than a user-specified target value (**Load factor**, default value = 1), corresponding buckling modes will be analyzed to identify the most critical members. These members will then be re-sized or additional elements and previously eliminated support points added, to suppress buckling modes.

The **Termination gap (TermGap)** input is a measure on the percentage error. When the stabilization routine gets to (or below) this value, it will be allowed to terminate. A default of zero (no difference between completely stabilized structure and current solution) is used, but a higher magnitude could be allocated and therefore result in a faster calculation.

Enabling the **Add Supports (AddSupports)** input allows the stabilization routine to once again consider areas of the geometry that were specified as supports, but that were not ‘active’ in the previous optimal solution. These may provide restraint for subsequently added stabilizing elements.

Note that this step should generally be the last in the optimization workflow, as other components may introduce a state of unstable equilibrium once more, thus negating the effect of the stabilization.

As the calculations involved in ensuring stability may require a reasonable amount of computational effort, the value of **Limit** (default = 50) is used to act as a threshold on the maximum solution size that the component will accept. If the number of nodes in the problem (note, not the number of joints in the structure) that is passed to the component exceeds the allocated value, a warning is issued (“*Layout contains too many nodes that may lead to slow progress, please increase node limit*”) and the stabilization is not undertaken. The user can choose to increase the value as necessary, on the understanding that this will require more resources.

The output is a new optimal **Solution (Sol)** along with data relating to its generation.

For an example of a Peregrine problem containing the **Stabilize** component, run the [PostProcess_GlobalStability.gh](#) file.

5.6.7.5 Input / Output

Input / Output	Description	Default Value
SolData (in)	Optimization solution data.	N/A
MaxJoints (in)	Maximum number of joints that can exist in the input structure. Use to suppress stabilization of very complex structures, which may require longer solution times.	50
LoadFactor (in)	If the calculated stability load factor is lower than this value, stabilization measures are attempted (adding members or increasing the cross-section of existing parts).	1
TermGap (in)	A measure on the percentage error of the solution. When the stabilization routine gets to (or below) this value, it will be allowed to terminate.	5
AddSupports (in)	Allows the stabilization routine to consider areas of the geometry that were specified as supports, but that were not ‘active’ in the previous optimal	True

5 - Component Reference

	solution. These may provide restraint for subsequently added stabilizing elements.	
Vol (out)	Volume of the solution structure.	N/A
SolData (out)	Optimization solution data.	N/A
Log (out)	Solution log.	N/A

5.7 View

5.7.1 Gallery Settings (Gallery)

5.7.1.1 Icon



Figure 78 - The Gallery Settings (Gallery) icon

5.7.1.2 Component

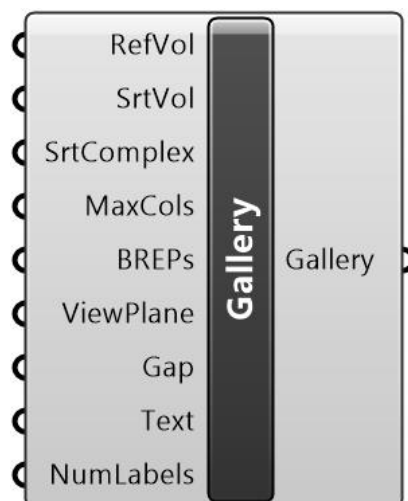

Figure 79 - The Gallery Settings (Gallery) component

5.7.1.3 Description

Gallery settings for **View Solution**

5.7.1.4 Summary

The **Gallery** component is used to control the display of multiple solutions in the **View Solution (View)** component. It accepts a **Reference Volume (RefVol)**, against which the optimized volumes can be compared. By default, this volume is set to zero and no comparison is undertaken. The **Gallery** output contains the display settings to be used in the **View Solution**.

For an example of a Peregrine problem containing the **Gallery** component, run the [LO_JointCost.gh](#) file.

5.7.1.5 Input / Output

Input / Output	Description	Default Value
RefVol (in)	Reference volume to compare solutions against (using document units).	0
SrtVol (in)	Higher numbers mean that volume is weighted higher when sorting solutions in the gallery. SrtVol and SrtComplex must both be above 1 to have an effect.	0
SrtComplex (in)	Higher numbers mean that structural complexity is weighted higher when sorting solutions in the gallery. SrtVol and SrtComplex must both be above 1 to have an effect.	0
MaxCols (in)	Max number of columns of solutions displayed in the gallery.	3
BREPs (in)	Display solutions as BREPs.	True
ViewPlane (in)	Select a view plane: (0) XY plane (1) XZ plane (2) YZ plane	0 (XY)
Gap (in)	Adjusts the gap between solutions.	1.5
Text (in)	Adjusts the scale of the caption text in the gallery.	1
NumLabels (in)	Set the number of solver output labels to display as captions under each solution.	2
Gallery (out)	Settings for controlling the display of solutions as a gallery.	N/A

5 - Component Reference

5.7.1.6 Example

An example of the **Gallery** output is presented in Figure 80:

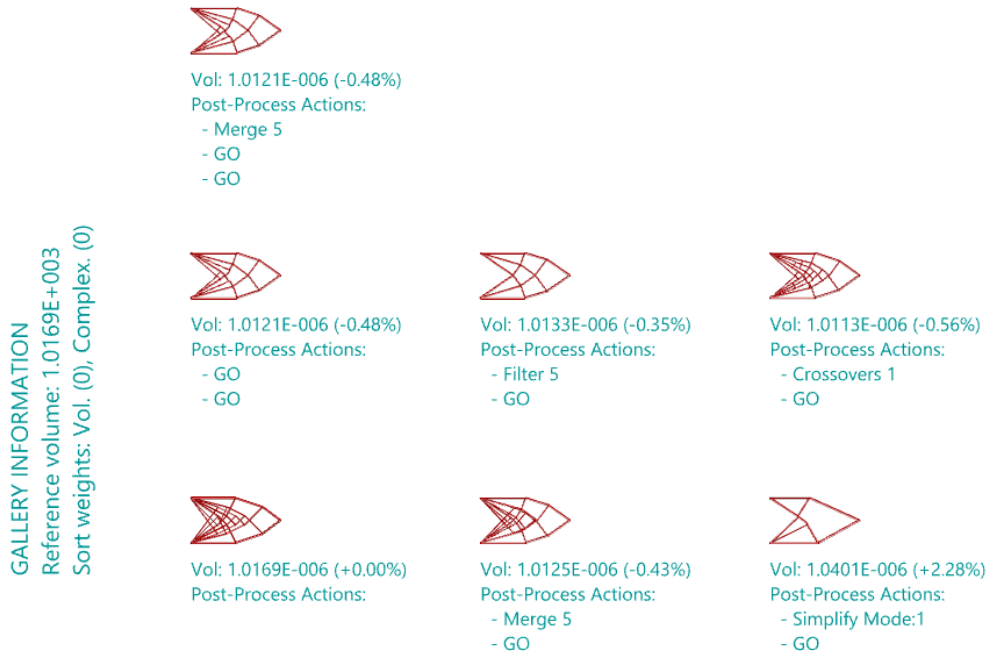

Figure 80 – An Example of Gallery output

5.7.2 View Solution (View)

5.7.2.1 Icon



Figure 81 – The View Solution icon

5.7.2.2 Component

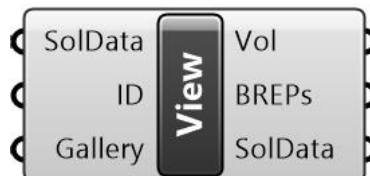

Figure 82 – The View Solution component

5.7.2.3 Description

Visualize a solution

5.7.2.4 Summary

The **View Solution** component accepts a Solution (**Sol**) from an optimization or post-process step, an optional **ID** (to highlight a particular solution) and a set of **Gallery** parameters which outline how the solution(s) are displayed in Rhino.

The output from the component can be passed to other components for further processing. However, the central function of the component is to display the structure(s) within the Rhino environment.

With respect to the output:

The **Volume (Vol)** is the volume(s) of the structures passed into the component.

The **Bars** are a list of the elements in the various layouts, as BREPs.

The **Solution (Sol)** is data relating to the problem setup and optimum structures.

For an example of a Peregrine problem containing the **View Solution** component, run the [LO_JointCost.gh](#) file.

5.7.2.5 Input / Output

Input / Output	Description	Default Value
SolData (in)	Optimization solution data.	N/A
ID (in)	Set the ID of the solution to highlight in the gallery output.	0
Vol (out)	Volume of the solution structure.	N/A
SolData (out)	Optimization solution data.	N/A
Log (out)	Solution log.	N/A

5.7.3 Solution Details (Details)

5.7.3.1 Icon



Figure 83 - The Solution Details icon

5.7.3.2 Component

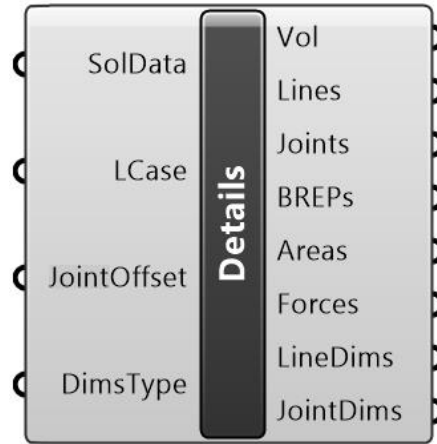

Figure 84 – The Solution Details (Details) component

5.7.3.3 Description

Show Solution details.

5.7.3.4 Summary

The **Solution Details (Details)** component accepts a Solution (**Sol**) from an optimization or post-process step and an integer representing the **Load Case** that the user wishes to determine the details for.

The output from the component comprises a range of information relating to the optimum structure for the specified **Load Case**.

Output from this component may be used to generate a single shell representation of the structure using the Grasshopper **MultiPipe** component (with Rhino version 7.2 or later).

5.7.3.5 Input/Output

Input / Output	Description	Default Value
SolData (in)	Optimization solution data.	N/A
LCase (in)	A load or group of loads to be applied to the structure as an independent case.	N/A
JointOffset (in)	Optionally include additional joints along members, each offset as a fraction of the member length from the member endpoints. If 0 then no additional joints are added. (Added to support compatibility with the MultiPipe component.)	0

5 - Component Reference

<i>DimsType</i> (in)	Member radius returned: 1: Outer radius (solid section or CHS) 2: Mid-surface radius (CHS) 3: Inner radius (CHS)	1
<i>Vol</i> (out)	Volume of the structure.	N/A
<i>Lines</i> (out)	The optimum structure represented by line elements.	N/A
<i>Joints</i> (out)	A list of coordinates describing the location of joints in the optimum structure.	N/A
<i>BREPs</i> (out)	The optimum structure represented by BREPs.	N/A
<i>Areas</i> (out)	A list of member cross-sectional areas (using document unit).	N/A
<i>Forces</i> (out)	A list of member axial forces (tension positive).	N/A
<i>LineDims</i> (out)	A list of key member radii of type determined by the <i>DimsType</i> input (using document unit).	N/A
<i>JointDims</i> (out)	The radius of the largest member connected to a given joint (using document unit).	N/A

5.7.3.6 Use with the Grasshopper *MultiPipe* component

An alternative to the ***Solution Viewer*** is to use the Grasshopper ***MultiPipe*** component, available in Rhino 7.2 or later, which generates a single shell representation of the structure, with smooth transitions between members at joints.

The ***MultiPipe*** component receives a set of curves as an input, with each curve being used to generate a member. Nodes are generated at points where two or more curves meet, and each node is assigned a radius that matches that of the closest point in a list of points passed via the ***SizePoints*** input. The radius of a pipe generated between nodes will smoothly transition between the radii of those nodes. The radius of each point in ***SizePoints*** is specified by the values in the ***NodeSize*** input.

When the ***Solution Details*** component is used with the ***MultiPipe*** component, the central portions of members can be sized correctly if intermediate joints (nodes) are created at positions:

$$\alpha L$$

$$1 - \alpha L$$

Where the member length is L and α is the offset from each endpoint as a fraction of the length of the member, specified by the **JointOffset** input of **Solution Details**. Note the following cases:

1. ($0 < \alpha < 0.5$)
Each member is split at two intermediate locations. The surface segment generated between the two new joints created will be nominally circular, with a radius that corresponds to that of the member in the Peregrine solution. The surface will smoothly transition from the original joints (which may have a larger radius) to the new joints.
2. ($\alpha = 0.5$)
Each member is split at its midpoint. The surface will smoothly transition from the original joints (which may have a larger radius) to the new midpoint joint.
3. ($\alpha = 0$)
Members are not split and no additional joints are created. This is the default value for **JointOffset**. This setting should not be used with **MultiPipe** as the members will not be sized correctly.

Before connecting the **Solution Details (Details)** component with **MultiPipe**, first specify a suitable **JointOffset** in the **Solution Details** component. Then connect the **Lines**, **Joints**, and **JointDims** outputs of **Solution Details** to the **Curves**, **SizePoints**, and **NodeSize** inputs of the **MultiPipe** component respectively. The **EndOffset** input of the **MultiPipe** component should typically be as small as possible but nonzero, but may be increased if the user finds that some pipes are bending too sharply at joints.

It is also possible to generate a hollow pipe structure using the **MultiPipe** component, by creating two **MultiPipe** structures using the inner and outer CHS radii of the members, converting these to watertight meshes and then subtracting the smaller mesh from the larger one. For an example of a Peregrine problem that is used to generate a **MultiPipe** structure, run the [HalfWheelMultipipe.gh](#) file.

5.8 Tools

5.8.1 Settings (Settings)

5.8.1.1 Icon



Figure 85 - The Settings icon

5.8.1.2 Component

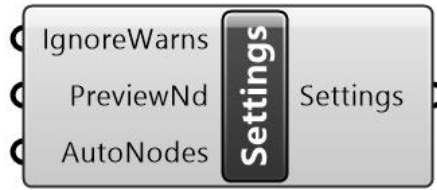

Figure 86 – The Settings component

5.8.1.3 Description

Adjust the Settings used in the Problem Specification.

5.8.1.4 Summary

The **Settings** component provides control over a number of LO solve related settings and outputs them in a form suitable for input into the **ProbSpec** component.

Occasionally Peregrine will issue warnings before attempting to solve a problem (e.g. relating to the solution time, if it is likely to be particularly long). These messages can be suppressed by setting the **IgnoreWarns** input to true.

The **Preview Nodes (PreviewNd)** input can be used to toggle display of the nodes generated by the **Layout Optimisation (LO)** component.

For an example of a Peregrine problem containing the **Settings**, component, run the [LO_UserNodes.gh](#) file

Note that, for files generated prior to Peregrine v5.0, the default **AutoNodes** setting may cause solutions to differ from the original. To rectify this:

- Use the “(3) None” setting for instances where **NodeDiv** = 0
- Use the “(2) Surface” setting for instances where **NodeDiv** > 0

5.8.1.5 Input / Output

Input / Output	Description	Default Value
IgnoreWarns (in)	Ignore any warnings (e.g. slow progress) that are generated on solve.	False
PreviewNd (in)	Preview the nodes used in the Layout Optimization (LO).	False
AutoNodes (in)	Controls how auto-generated nodes are considered alongside UserNodes, when these have also been defined. Default = 1.	1

5 - Component Reference

	<p>(1) All: Generate and consider auto-nodes on and throughout the domain</p> <p>(2) Surface: Generate and consider auto-nodes only on the surfaces of the domain (boundaries if 2D)</p> <p>(3) None: Do not generate or consider auto-nodes</p> <p>Note that, in all cases, supported and loaded nodes will be considered, irrespective of whether they are auto- or user-generated.</p>	
Settings (out)	Settings used in the problem specification.	N/A

5.8.2 Remove Duplicated Solutions (DeDupe)

5.8.2.1 Icon



Figure 87 – The Remove Duplicated Solutions (DeDupe) icon

5.8.2.2 Component



Figure 88 – The Remove Duplicated Solutions (DeDupe) component

5.8.2.3 Description

Remove duplicated solutions

5.8.2.4 Summary

The **Remove Duplicated Solutions (DeDupe)** component accepts a series of Solutions (**Sol**) and removes repeated instances (i.e. those with the same layout and optimal volume as an existing one). This is especially useful when e.g. comparing the effect of various levels of joint cost penalization.

For an example of a Peregrine problem containing **Remove Duplicated Solutions**, run the [LO_JointCost.gh](#) file

5.8.2.5 *Input/Output*

Input / Output	Description	Default Value
<i>SolData</i> (in)	Optimization solution data.	N/A
<i>SolData</i> (in)	Optimization solution data, with duplicates filtered out.	N/A

5.9 License

5.9.1 Peregrine

5.9.1.1 *Icon*

Figure 89 - The License icon

5.9.1.2 *Component*

Figure 90 - The License component

Right-clicking on the Peregrine License component will bring up the context menu, as seen in Figure 91:

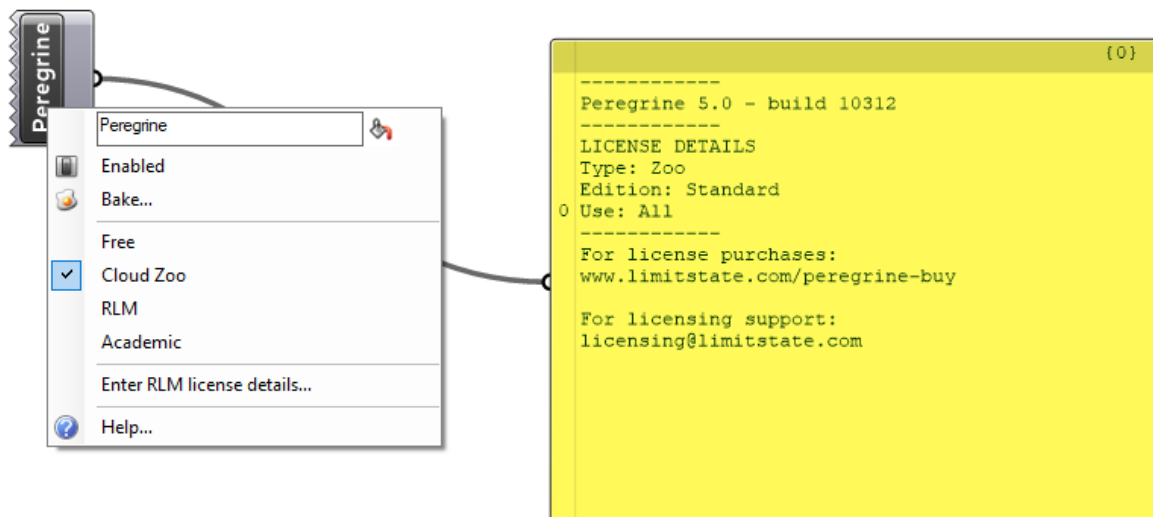

Figure 91 - The Peregrine License component and licensing context menu

5.9.1.3 Description

Peregrine license component

5.9.1.4 Summary

The **License** component is used to change the license type, and includes information relating to the specific version of the software, as well as links to pertinent websites. There are four types of licenses available:

1. Free
2. Cloud Zoo
3. RLM
4. Academic

For further details on the different options available, please refer to Section 2.3.

5.9.1.5 Input / Output

Input / Output	Description	Default Value
Log (out)	Outputs the results of the license check	N/A

6 Appendix

6.1 Theory

6.1.1 Layout Optimization

The **LO** component undertakes a layout optimization of the problem. Layout optimization is a numerical approach utilized to design (near-) optimal truss structures. It directly identifies the optimal connectivity of nodes in a design domain.

A standard layout optimization has four steps:

1. Firstly, a design domain is specified along with load and support conditions;
2. Secondly, this design domain is discretized using nodes;
3. Thirdly, potential members are generated by connecting nodes, forming a 'ground structure';
4. Finally, the most efficient arrangement of members (which will be a small subset of the 'ground structure') is identified by solving a linear programming (LP) problem.

An example of a layout optimization is provided in Figure 92. Here, the design space is shown in (a), while the optimized structure is shown in (b).

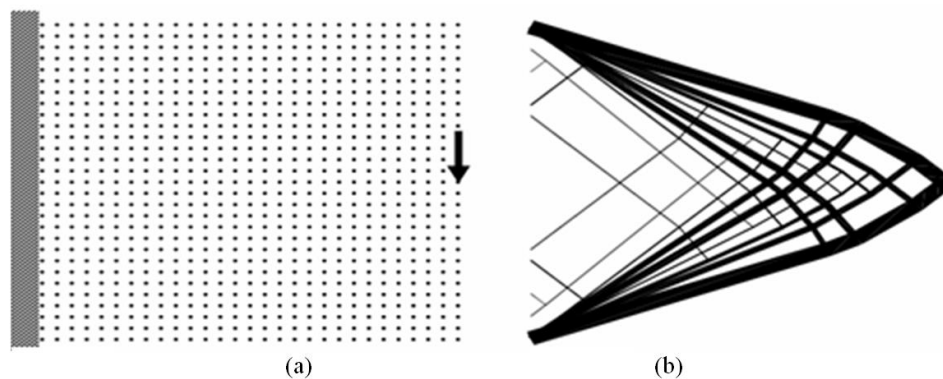

Figure 92 – Example layout optimization

It should be noted that a 'ground structure' normally contains a very large number of potential truss layouts, permitting highly efficient, though not necessarily practical, solutions to be found.

6.1.1.1 Formulation

The LP formulation for layout optimization was first proposed by Dorn et al. (1964) and more recently was made efficient for single and multiple load cases problems respectively by Gilbert and Tyas (2003) and Pritchard et al. (2005). The formulation used here is:

$$\min V = \mathbf{l}^T \mathbf{a}$$

Subject to:

$$\text{for all } \alpha \in \mathbb{F} \begin{cases} \mathbf{B}\mathbf{q}^\alpha = \mathbf{f}^\alpha \\ -\sigma^- \mathbf{a} \leq \mathbf{q}^\alpha \leq \sigma^+ \mathbf{a} \\ \mathbf{a} \geq 0 \end{cases}$$

where V is structural volume, \mathbf{l} and \mathbf{a} are vectors of member lengths and areas, respectively. \mathbf{B} is an equilibrium matrix comprising direction cosines; \mathbf{q} is a vector containing the internal bar forces and \mathbf{f} is a vector containing the external forces. Also σ^+ and σ^- are limiting tensile and compressive stresses respectively, $\mathbb{F} = \{1, 2, \dots, p\}$ is a load case set, where α is the load case identifier and p represents the total number of load cases.

6.1.1.2 Adaptive Solution Scheme

To improve computational efficiency of layout optimization, Gilbert and Tyas (2003) proposed an adaptive solution scheme. It starts with a 'ground structure' containing only a few potential members, and then gradually adds new members into the 'reduced' optimization problem. It is important to note that the adaptive solution scheme has no impact on the structural efficiency of the outcome truss layout, i.e., it is mathematically guaranteed that the structural volume obtained is the same as that derived using the fully connected formulation. For more information on this, the reader is referred to the original paper. A Python implementation of this method is also freely available; see He et al. (2019).

6.1.1.3 Layout Extraction

The raw solution derived from layout optimization may contain a considerable number of thin members. Most of these are not structurally important and can be deleted from the design. For this reason, a threshold 'filter' number is used to select only the important members from the raw solution. This 'filter' number will be validated so the resulting layout is as efficient as the raw solution.

6.1.2 Geometry Optimization

The **Geometry Optimization** component seeks to both simplify and improve on the solution that it is passed. It does this by undertaking a geometry optimization (GO). Here, the joint positions of the structure as provided are moved to reduce the volume of the structure. As part of this process, it is possible that joints may be merged. A description of the Geometry Optimization process is provided in He and Gilbert (2015).

When considering the geometry optimization process in isolation, for a problem involving a single load case, without self-weight, the optimization problem is written as:

$$\min_{x,y,a,q} V = \mathbf{l}(\mathbf{x}, \mathbf{y})^T \mathbf{a}$$

Subject to:

$$\mathbf{B}_{(x,y)} \mathbf{q} = \mathbf{f}$$

$$-\sigma^- \mathbf{a} \leq \mathbf{q} \leq \sigma^+ \mathbf{a}$$

$$\mathbf{a} \geq 0$$

Where \mathbf{l} is a vector containing the lengths of the truss bars. The optimization variables in this case are x , y , a and q . It is evident that the objective function and equality constraint are both now non-linear (c.f. the layout optimization problem). Without loss of generality, the GO can be categorized as a non-linear, non-convex optimization problem.

For more information on the GO problem and the practicalities involved in its implementation, the reader is referred to the original paper.

6.1.3 Joint Costs

Joint costs are a Geometry Optimization technique proposed by Parkes (1975). According to his formulation, a notional joint length, s , is added to the length of each bar. Thus, the computed volume of the truss structure under consideration becomes:

$$V = \tilde{\mathbf{l}}^T \mathbf{a}$$

Where $\tilde{\mathbf{l}}$ is a vector containing modified truss bar lengths (i.e. $\{l_1 + s, l_2 + s, \dots, l_m + s\}$, for a problem involving m bars).

Note that though this can simplify the truss layout, the calculated structural volume will clearly always increase because of the inclusion of additional joint lengths. However, after the optimization has been completed, the 'standard' volume can be calculated by summing up the volumes of all bars, excluding the joint lengths from this calculation (all volumes reported herein were calculated in this way).

The updated layout optimization problem, now including joint lengths and also self-weight, can be stated as:

$$\min V = \tilde{\mathbf{l}}^T \mathbf{a}$$

Subject to:

$$\text{for all } \alpha \in \mathbb{F} \begin{cases} \mathbf{B}\mathbf{q}^\alpha + \mathbf{W}\mathbf{a} = \mathbf{f}^\alpha \\ -\sigma^- \mathbf{a} \leq \mathbf{q}^\alpha \leq \sigma^+ \mathbf{a} \end{cases}$$

Where \mathbf{W} contains self-weight coefficients, here assuming self-weight to be lumped at the nodes.

6.1.4 Example Problem

The following example considers both geometry optimization (GO) and joint length rationalization of a problem. It is taken from He and Gilbert (2015).

The example was first considered by Hemp (1974). The problem involves application of a point load at mid-height between two pinned supports. Hemp quoted the analytical volume to be $4.34P L/\sigma$, but Lewinski (2005) repeated the calculations using greater precision to obtain a more accurate solution, $4.32168P L/\sigma$.

A sample layout optimization solution and corresponding rationalized (**GO**) solutions are also shown in Figure 93. It is evident that both rationalization techniques allow simplified solutions to be obtained when compared to the original layout optimization solution (a). However, whereas the volume associated with the solution obtained using joint length rationalization (b) is 1.49 % above the exact value, the solution obtained using geometry optimization rationalization (c) is only 0.23 % above the exact value, a significant improvement on the original layout optimization error of 0.75 %.

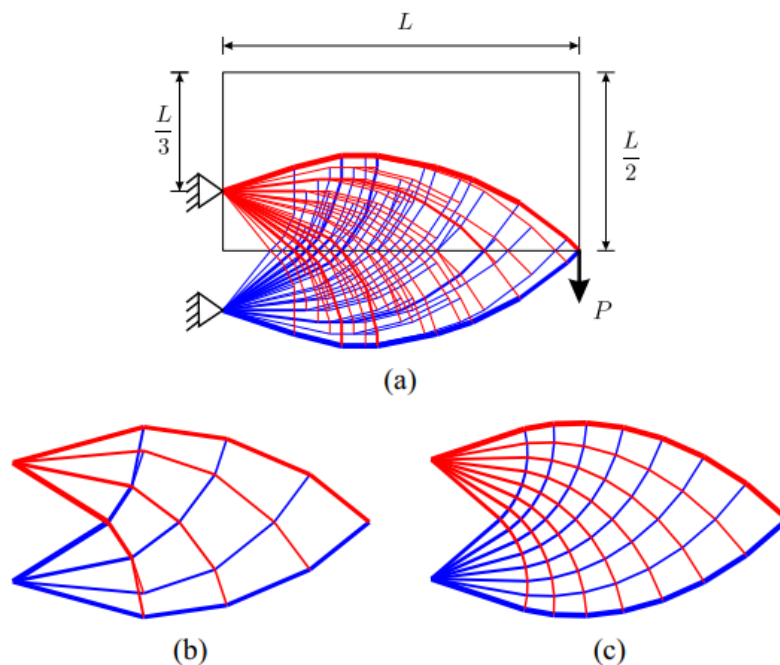

Figure 93 – Rationalization of a cantilever truss (a) by using joint cost and GO (b) and GO (c)

6.2 Known Issues

- It is not possible to prescribe limits on structural deflection. To address this, stress limits can be scaled down to compensate.

7 References

Dorn W (1964). Automatic design of optimal structures. *Journal de Mecanique*, 3:25–52.

Gilbert M and Tyas A (2003), Layout optimization of large-scale pin-jointed frames. *Engineering Computations*, 20(8):1044-1064.

He L and Gilbert M (2015), Rationalization of trusses generated via layout optimization. *Structural and Multidisciplinary Optimization*, 52(4):677-694.

He L, Gilbert M and Song X (2019), A Python script for adaptive layout optimization of trusses. *Structural and Multidisciplinary Optimization*, 60(2):835–847.

Hemp WS (1974), Michell frameworks for uniform load between fixed supports. *Engineering Optimization* 1:61–69.

Lewinski T (2005) Personal communication.

Parkes EW (1975), Joints in optimum frameworks. *International Journal of Solids and Structures*, 11(9):1017–1022.

Pritchard T, Gilbert M and Tyas A (2005) Plastic layout optimization of large-scale frameworks subject to multiple load cases, member self-weight and with joint length penalties. *Proc of 6th World Congresses of Structural and Multidisciplinary Optimization*, Rio de Janeiro, Brazil.



limitstate

The Innovation Centre
217 Portobello
Sheffield, S1 4DP
United Kingdom

limitstate.com/peregrine
info@limitstate.com
+44 (0) 114 224 2240